

PHILIPS **MAGNAVOX**

Video Cassette Recorder
VRX463
Owner's Manual



I M P O R T A N T !

Return Your Warranty Registration Card
Within 10 Days. See Why Inside.

Return your Warranty Registration card today to ensure you receive all the benefits you're entitled to.

Once your PHILIPS MAGNAVOX purchase is registered, you're eligible to receive all the privileges of owning a PHILIPS MAGNAVOX product. So complete and return the Warranty Registration Card enclosed with your purchase at once. And take advantage of these important benefits.

Warranty Verification

Registering your product within 10 days confirms your right to maximum protection under the terms and conditions of your PHILIPS MAGNAVOX warranty.

Owner Confirmation

Your completed Warranty Registration Card serves as verification of ownership in the event of product theft or loss.

Model Registration

Returning your Warranty Registration Card right away guarantees you'll receive all the information and special offers which you qualify for as the owner of your model.

PHILIPS MAGNAVOX

Congratulations on your purchase, and welcome to the "family!"

Dear PHILIPS MAGNAVOX product owner:

Thank you for your confidence in PHILIPS MAGNAVOX. You've selected one of the best-built, best-backed products available today. And we'll do everything in our power to keep you happy with your purchase for many years to come.

As a member of the PHILIPS MAGNAVOX "family," you're entitled to protection by one of the most comprehensive warranties and outstanding service networks in the industry.

What's more, your purchase guarantees you'll receive all the information and special offers for which you qualify, plus easy access to accessories from our convenient home shopping network.

And most importantly you can count on our uncompromising commitment to your total satisfaction.

All of this is our way of saying welcome-and thanks for investing in a PHILIPS MAGNAVOX product.

Sincerely,



Robert Minkhorst
President and Chief Executive Officer

P.S. Remember, to get the most from your PHILIPS MAGNAVOX product, you must return your Warranty Registration Card within 10 days. So please mail it to us right now!



Know these

safety symbols



 This "bolt of lightning" indicates uninsulated material within your unit may cause an electrical shock. For the safety of everyone in your household, please do not remove product covering.

 The "exclamation point" calls attention to features for which you should read the enclosed literature closely to prevent operating and maintenance problems.

WARNING: TO PREVENT FIRE OR SHOCK HAZARD, DO NOT EXPOSE THIS EQUIPMENT TO RAIN OR MOISTURE.

CAUTION: To prevent electric shock, match wide blade of plug to wide slot, and fully insert.

ATTENTION: Pour éviter les chocs électriques, introduire la lame la plus large de la fiche dans la borne correspondante de la prise et pousser jusqu'au fond.

For Customer Use

Enter below the Serial No. which is located on the rear of the cabinet. Retain this information for future reference.

Model No. _____
Serial No. _____

Welcome to your VCR owner's manual.

This manual has six sections: Setting Up Your VCR; Description of Controls; Basic Operations; Recording; Playing; and Information You May Need. The instructions explain all of the VCR's features, which are listed below. You cannot hurt your VCR by trying the features! So read on – and relax.

Features

- Automatic Channel Programming
- On-Screen Status Displays in English or Spanish
- MTS (Multi-Channel Television Sound) System
- Hi-Fi Stereo Tape Playback
- Automatic Clock Setting
- VCR Plus+ Programming System
- Remote Control With Capability to Operate TV, Cable Box, and Digital Satellite System Receiver
- Remote Locator
- Controller (for Cable Box or Digital Satellite System Receiver)
- Index Search
- Repeat Playback
- Daylight-Saving Time
- Automatic Head Cleaner
- Tape Counter Memory

Safety Precautions

Warning: To prevent fire or shock hazard, do not expose this equipment to rain or moisture.

FCC Warning: Any unauthorized changes or modifications to this equipment void the user's authority to operate it.

This VCR, equipped with a HQ (high quality) system, is compatible with existing VHS (video home system) equipment.

Philips Consumer Electronics Company recommends that you use only video cassette tapes that have been tested and inspected for use in two, four, six, and eight hour VCRs, and which are labeled with the **VHS** mark. The use of tapes that have not been inspected for use in two, four, six, and eight hour VCRs may result in poor picture quality and excessive deposits on the video heads, which may not be covered by the warranty if damage occurs.

Note to the Cable TV System Installer: This reminder is provided to call the Cable TV system installer's attention to Article 820-40 of the National Electrical Code, which provides guidelines for proper grounding – in particular, specifying that the cable ground shall be connected to the grounding system of the building, as close to the point of cable entry as possible.

Operation is subject to the following two conditions: (1) this device may not cause interference, and (2) this device must accept any interference, including interference that may cause undesired operation of the device.

Copyright 1997 Philips Consumer Electronics Company. All rights reserved.

VCR Plus+C³ and PlusCode are trademarks of Gemstar Development Corporation. The VCR Plus+ system is manufactured under license from Gemstar Development Corporation. DSS™ is an official trademark of DIRECTV, Inc., a unit of GM Hughes Electronics.

Helpful Hint

- Before doing anything else, record the VCR's model and serial numbers in the spaces provided on page two. These numbers will help us assist you if you ever call for help.

4 Table of Contents

Setting Up Your VCR

Introduction	3
Table of Contents	4
Before Using Your VCR	5
Hookups Without a Cable Box	6 - 7
Hookups With a Cable Box/DSS Receiver	8 - 9
Turning on Your VCR	10 - 11
Automatic Channel Programming	12 - 13
Setting the Clock	14 - 17
Daylight-Saving Time Selection	18
Language Selection	19

Description of Controls

Remote Control Buttons	20 - 21
Display Panel	22 - 23
Front Panel	24
Rear Panel	25
Setting the Remote Control to Operate a TV	26
Setting the Remote Control to Operate a Cable Box/DSS Receiver	27
On-Screen Status Displays	28
Remote Locator	29

Basic Operations

Playing	30
Recording	31

Recording

One Touch Recording	32
Recording One Channel/Watching Another	33
Timer Recording	34 - 37
Setting Up the VCR Plus+ Programming System	38 - 39
Timer Recording With the VCR Plus+ Programming System	40 - 41
Connecting the Controller	42
Setting the Controller to Operate a Cable Box	43 - 44
Setting the Controller to Operate a DSS Receiver	45 - 46
Rerecording (Tape Duplication)	47
Index Search	48

Playing

Multi-Channel Television Sound System	49 - 50
Hi-Fi Stereo Tape Playback	51
Tape Counter Memory	52
Go-To Feature	53
Repeat Playback	54
Video Stabilizer	55
Playback Options	56
Automatic Operation Features	57

Information You May Need

Glossary	58
Specifications	59
Helpful Hints	60 - 61
Limited Warranty	62
Index	63
Supplied Accessories	64

Before Using Your VCR 5

Putting Batteries in the Remote Control

1

To remove the battery compartment lid, push in the tab, then pull up the lid.

2

Place three AA batteries inside the battery compartment with their polarities (+ and - ends) aligned as indicated.

3

Replace the battery compartment lid.

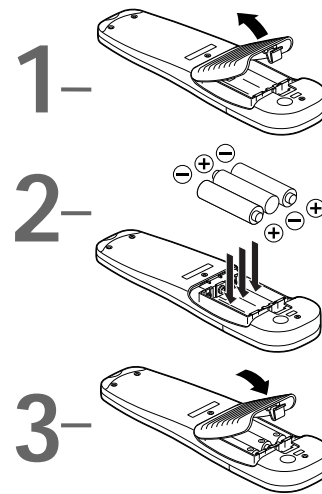

Using the Remote Control

- Point the remote control at the VCR's remote sensor.
- Do not put objects between the remote control and the VCR.
- Press the VCR button before pressing other VCR operation buttons.
- Press the TV button before pressing other TV operation buttons.
- Press the CBL/DSS button before pressing other Cable Box or DSS Receiver operation buttons.

Erase Protection

Video cassette tapes have record tabs to ensure that recordings are not accidentally erased.

1

To prevent accidental erasure, break off the tab with a screwdriver.

2

To record again, cover the hole with cellophane tape.

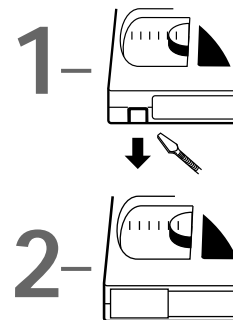

VCR Maintenance

- In this VCR, use only tapes with the **VHS** mark.
- Make sure any light adhesive stick-on notes are removed from the video cassette tape before putting the tape in the VCR. Removable labels like these can jam the VCR.
- Periodic maintenance is required to maintain your VCR's performance. Your VCR has an automatic head cleaner, but the video heads eventually will require cleaning or replacement. Cleaning or replacement of the video heads should be performed only by an authorized service center.

Helpful Hints

- The remote control and its batteries are supplied.
- Do not mix alkaline and manganese batteries.
- Do not mix old and new batteries.

6 Hookups Without a Cable Box

The basic VCR/TV connection – antenna/cable to VCR to TV – is shown below. If you have a Cable Box or a Digital Satellite System Receiver, please refer to pages eight-nine. After you hook up the VCR, please go to page 10 to turn on the VCR.

1

Disconnect the antenna or cable from your TV.

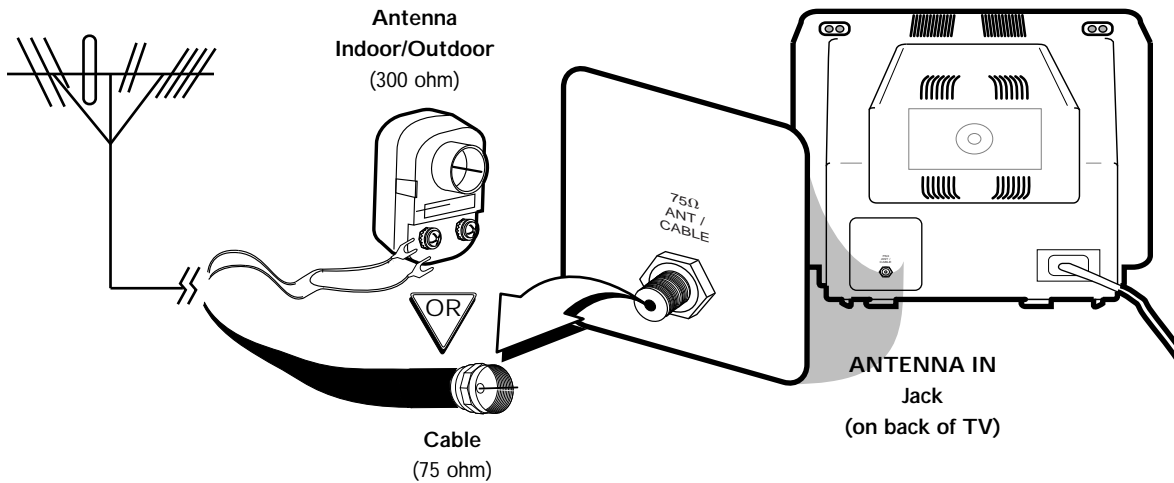

2

Connect the antenna or cable to the ANT(enna) IN Jack on the back of the VCR.

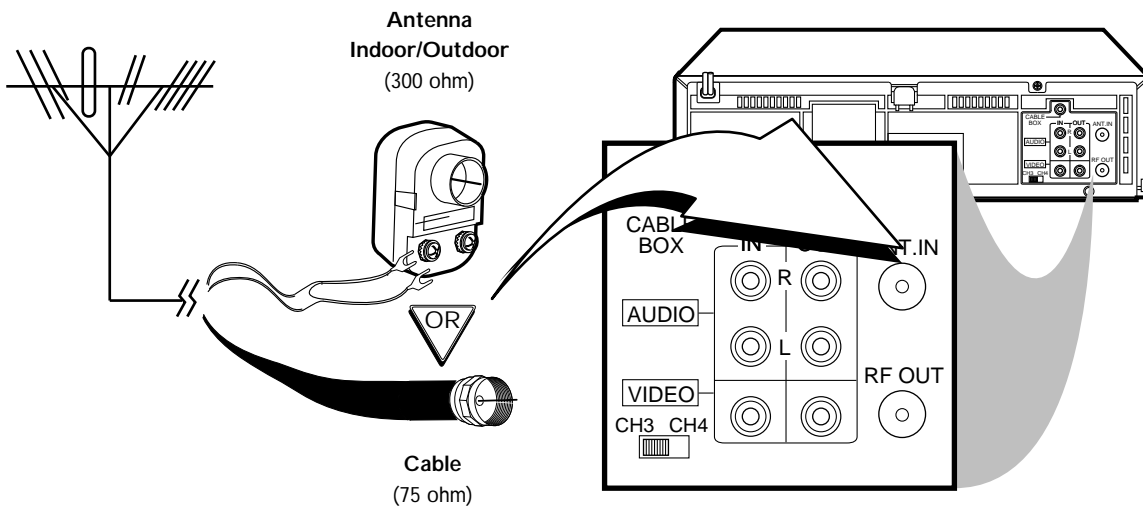

Hookups Without a Cable Box (cont'd) 7

3

Connect the RF coaxial cable (supplied) to the RF OUT Jack on the back of the VCR and to the ANTENNA IN Jack on the TV. (You may use either a snap-on type or screw-on type of coaxial cable, whichever you prefer. A snap-on type is supplied.)

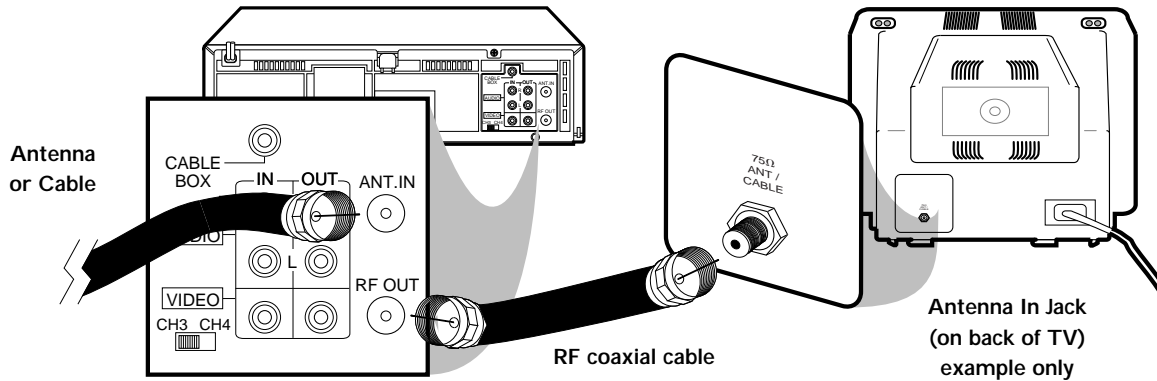

4

Plug in the TV and the VCR.

5

Set the CH3/CH4 switch on the back of the VCR to CH3 or CH4, whichever channel is not used or least used in your area. To operate your VCR with your TV, set the TV to the same channel. For example, when playing a tape, if the CH3/CH4 switch is set to CH3, the TV should be on channel 3.

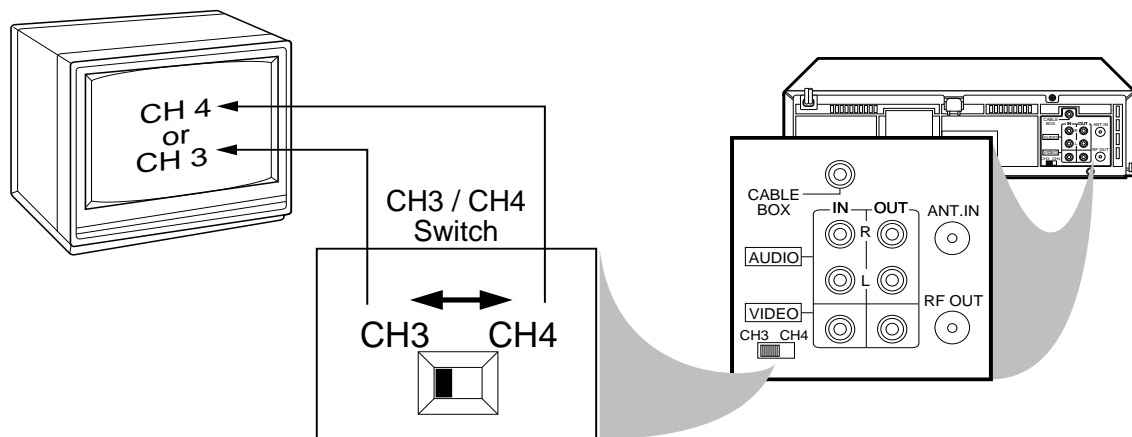

6

You are ready to turn on the VCR. Please go to page 10 before turning on the VCR.

8 Hookups With a Cable Box/DSS Receiver

This connection allows you to view any channel. After you connect the Cable Box/DSS Receiver, VCR, and TV as shown below, the features described on this page will be available.

1. Connect a Cable signal to the IN Jack on the Cable Box/DSS Receiver.

2. Use an RF coaxial cable (supplied) to connect the OUT Jack on the Cable Box/DSS Receiver to the ANT(enna) IN Jack on the VCR.

3. Use a second RF coaxial cable to connect the RF OUT Jack on the VCR to the TV's Antenna IN jack.

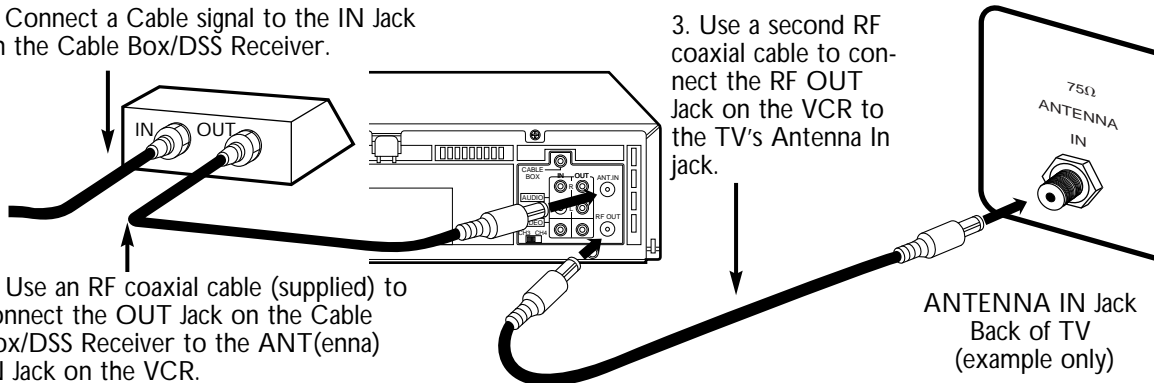

Recording or Viewing a Scrambled or Unscrambled Channel

1

With the VCR on and in VCR position (the VCR light will appear on the display panel), use the CHANNEL Up/Down buttons to set the VCR to the Cable Box/DSS Receiver output channel (03 or 04). Set the CH3/CH4 switch on the back of the VCR to the same channel.

2

Set the TV to the same output channel.

3

Use the CHANNEL Up/Down buttons at the Cable Box/DSS Receiver to select the channel you want to watch or record.

Watching TV With the VCR Turned Off

1

Use the CHANNEL Up/Down buttons at the TV to set the TV to the Cable Box/DSS Receiver output channel (03 or 04).

2

Use the CHANNEL Up/Down buttons at the Cable Box/DSS Receiver to select the channel you want to watch.

Timer Recordings

With this connection, you may set a timer recording as described on pages 34 - 36. However, remember the following:

- Set the TV and the VCR to the Cable Box/DSS Receiver output channel (03 or 04).
- When you are prompted to enter the channel you want to record, select channel 03 or 04 (the Cable Box/DSS Receiver output channel). This is step 5 on page 35. But, if you are using the Controller, enter the Cable Box channel that you wish to record.
- Set your Cable Box/DSS Receiver to the channel you want to record.
- Leave the Cable Box/DSS Receiver on while recording.

Helpful Hints

- With this hookup, select channels at the Cable Box/DSS Receiver.
- If your Cable Box/DSS Receiver has VIDEO/AUDIO OUT Jacks, use video and audio cables to connect these jacks to the VIDEO/AUDIO IN Jacks on the VCR.
- You can not view a channel other than the one you are recording. (The instructions on page 33 do not work with this hookup.)
- You cannot program channels with this hookup (as discussed on page 12).
- You may only program a timer recording for one channel at a time if you are not using the Controller. If you are using the Controller, you may program timer recordings for more than one channel at a time. Details are on pages 42 - 46.

Hookups With a Cable Box/DSS Receiver (cont'd) 9

This connection allows you to program an unattended recording of more than one unscrambled channel and to watch one channel while recording another. After you connect the VCR, Cable Box/DSS Receiver, and TV as shown below, the features on this page will be available.

1. Connect a Cable signal to the VCR's ANT(enna) IN Jack.

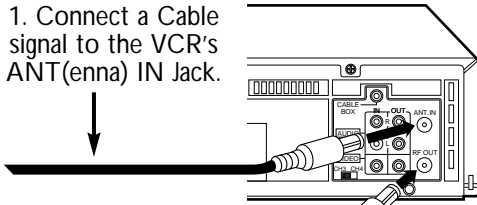

2. Use an RF coaxial cable (supplied) to connect the RF OUT Jack on the VCR to the IN Jack on the Cable Box/DSS Receiver.



3. Use a second RF coaxial cable to connect the OUT Jack on the Cable Box/DSS Receiver to the TV's ANTENNA IN Jack.

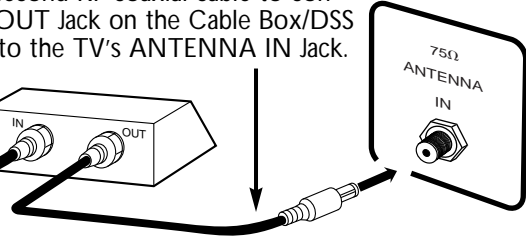

ANTENNA IN Jack
(on back of TV)

Recording One Channel/Watching Another

1

Put the Cable Box/DSS Receiver on the same channel as the VCR's CH3/CH4 switch. Put the TV on the Cable Box output channel (03 or 04).

With the VCR in VCR position (the VCR light will appear on the display panel), use the CHANNEL Up/Down buttons at the VCR to select the channel you want to record. Start the recording.

2

Press the VCR/TV button once to put the VCR in TV position. (The VCR light will disappear.)

3

Use the CHANNEL Up/Down buttons on the TV to set the TV to the Cable Box/DSS Receiver output channel (03 or 04).

4

Use the CHANNEL Up/Down buttons on the Cable Box/DSS Receiver to select the channel you want to watch.

Playing a Tape

1

Press the VCR/TV button to put the VCR in VCR position (the VCR light will appear on the display panel).

2

Make sure the Cable Box/DSS Receiver is on the same channel as the VCR's CH3/CH4 switch.

3

Use the CHANNEL Up/Down buttons at the TV to set the TV to the Cable Box output channel (03 or 04).

4

Press the PLAY button to play the tape.

Helpful Hints

- You cannot record scrambled channels with this connection.
- This connection may not work with your cable system. You may have to use the connection shown on page eight.
- To return to the channel being recorded, use the CHANNEL Up/Down buttons at the Cable Box to set the Cable Box to the same channel as the CH3/CH4 switch. Then, press the VCR/TV button to put the VCR in VCR position.

10 Turning on Your VCR

Before turning on your VCR, make sure there are batteries in the remote control. *Details are on page five.* Make sure the VCR, TV, and Cable Box/DSS Receiver (if applicable) are connected. *Details are on pages six - nine.* If you are going to set up the Controller now, connect the Controller before you begin. *Details are on page 42.* If you plan to set up the VCR Plus+ Programming System now, complete the charts on page 38 before you begin.

1

Press the VCR button, then press the POWER button. The VCR will come on.

2

Turn on the TV. Set it to channel 3 or 4, whichever the CH3/CH4 switch on the back of the VCR is set to. The menu shown below will appear.

TO SELECT PUSH NO. SHOWN

1 ENGLISH (ON)
2 ESPAÑOL

MAKE SELECTION OR
PUSH MENU TO CONTINUE

3

Press the Number 1 button to select English on-screen displays. (ON) will appear to the right of ENGLISH on-screen. **Or,** **press the Number 2 button** to select Spanish on-screen displays. (SI) will appear to the right of ESPAÑOL on-screen.

TO SELECT PUSH NO. SHOWN

1 ENGLISH (ON)
2 ESPAÑOL

MAKE SELECTION OR
PUSH MENU TO CONTINUE

4

Press the MENU button. The menu shown below will appear, giving you the option to set up the Cable Box Controller now.

CABLE BOX CONTROLLER

OFF

TO SELECT PRESS NUMBER

1 ON
2 OFF

TO CONTINUE PUSH MENU
TO END PUSH EXIT

5

If you do not want to set up the Cable Box Controller now, press the Number 2 button to leave the Cable Box Controller turned OFF. Proceed to step 6 on page 11. You may set up the Controller later by following the instructions on pages 42 - 46.

If you do want to set up the Cable Box Controller now, press the Number 1 button to turn the Cable Box Controller ON. Press the MENU button, then follow steps 4 - 6 on page 14. When you finish setting the clock, complete steps 7 - 11 on page 44. When you finish setting up the Cable Box Controller, go to step 9 on page 11.

2

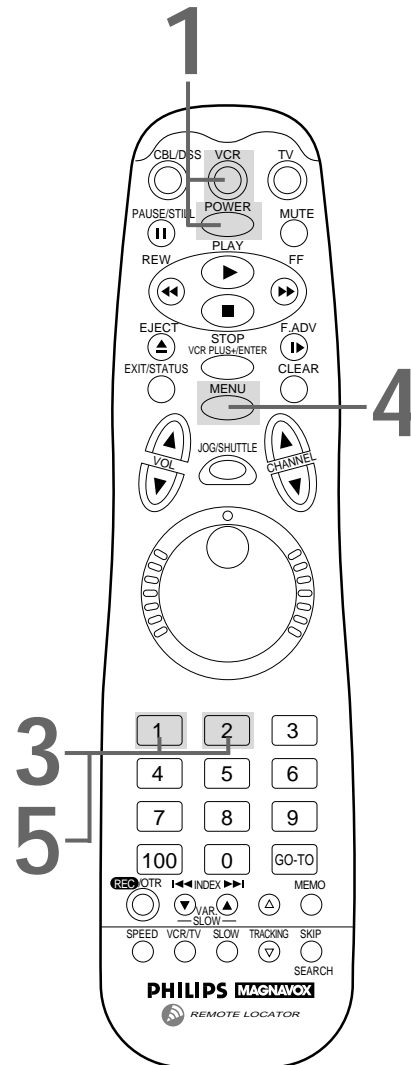
 Turn on the TV.

Helpful Hints

- Leave the Cable Box turned on if you plan to set up the Cable Box Controller now.
- Set the Cable Box to a channel other than channel 09.
- Auto may flash or --:-- may appear on the display panel until the clock is set.
- If you do not want to program channels now, press the STOP button at step 7. TUNER NOT SET will appear on-screen briefly.

Turning on Your VCR (cont'd) 11

6

Press the **MENU** button. The menu shown below will appear.

CONNECT ANTENNA OR CABLE
TO VCR

THEN...
PUSH CH UP KEY

OR...
FOR PLAY ONLY - PUSH STOP

7

Press the **CHANNEL Up** button to begin automatic channel programming. AUTO SET PROCEEDING/PLEASE WAIT will appear on-screen. The VCR will place all of the channels you receive into its memory, so when you scan through channels using the CHANNEL Up/Down buttons, you'll only scan through channels that you receive.

8

When channels are programmed, AUTO SET COMPLETED will appear on-screen briefly. Then, the following menu will appear, giving you the option to set up the VCR Plus+ Programming System now, if you prefer.

VCR PLUS+ USER
TO SET UP VCR PLUS+
CROSS REFERENCE CHANNEL
MAP, REFER TO
INSTRUCTION BOOK.
PUSH MENU TO SET REF MAP
OR...
TO END PUSH EXIT

9

If you *do not* want to set up the VCR Plus+ Programming System now, press the **EXIT/STATUS** button. You may set up the VCR Plus+ Programming System later by following the instructions on pages 38 - 39.

If you *do* want to set up the VCR Plus+ Programming System now, press the **MENU** button. Follow the instructions from step 6 on page 39 to complete this task.

8 Wait for the VCR to program channels.

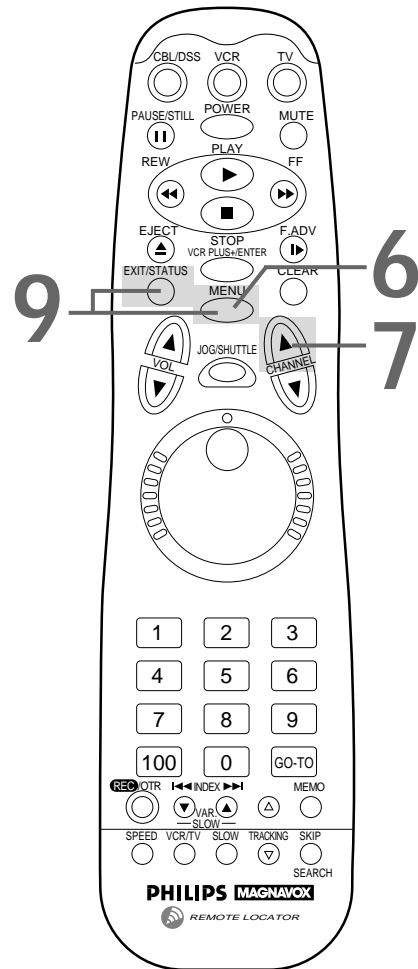

Helpful Hint

- You may not be able to program channels at step 7 if you are using a Cable Box or DSS Receiver.

12 Automatic Channel Programming

Programming Channels

Although your VCR may automatically memorize the channels you receive when you turn it on for the first time, this function lets you reprogram channels. Make each entry within one minute of the previous entry.

1

Press the **VCR** button, then press the **MENU** button to bring up the main menu display.

TO SELECT PUSH NO. SHOWN

- 1 PROGRAM
- 2 VCR SET UP
- 3 TUNER SET UP
- 4 INPUT SELECT
- 5 SET CLOCK
- 6 SET REMOTE LOCATOR

TO END PUSH EXIT

2

Press the **Number 3** button to select TUNER SET UP.

TO SELECT PUSH NO. SHOWN

- 1 TV
 - 2 CABLE TV (ON)
 - 3 AUTO PROGRAMMING
 - 4 ADD/DELETE CH
 - 5 CH MEMORY REVIEW
 - 6 TV STEREO (ON)
 - 7 SECOND AUDIO
- TO END PUSH EXIT

3

Press the **Number 1** button to select TV (if you have an antenna) or the **Number 2** button to select CABLE TV (if you have a cable connection). (ON) will appear to the right of your selection.

4

Press the **Number 3** button to select AUTO PROGRAMMING. AUTO SET PROCEEDING/PLEASE WAIT and a scale that shows the progress of programming will appear on-screen. The VCR will place all the channels you receive into its memory.

5

Wait for a few minutes while the VCR programs channels. When programming is complete, AUTO SET COMPLETED will appear on-screen. Then, the programming of the lowest channel number placed in the VCR's memory will appear on-screen. Now when you press the CHANNEL Up/Down buttons, you will scan only through channels you receive.

5 Wait for the VCR to program channels.

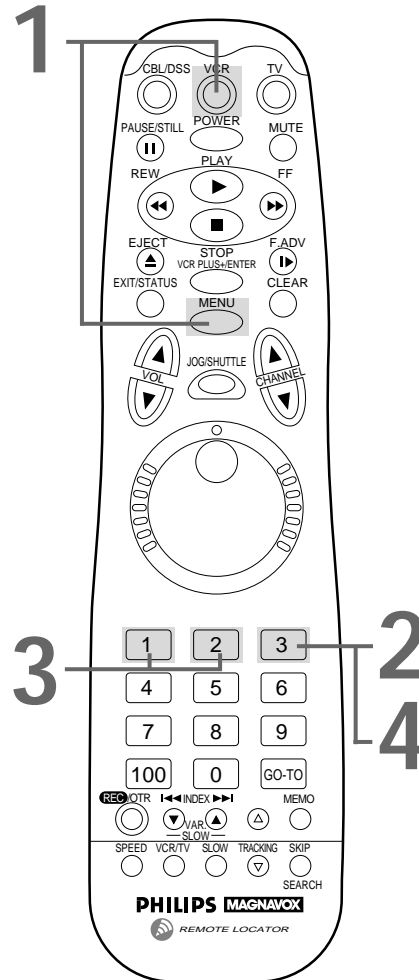

Helpful Hints

- If the channel you select has no broadcast, the screen will be solid blue. The screen will remain blue until you select an active channel.
- Line Input mode will always be stored in the VCR's memory as channel 00. When you press Number buttons 00, A/V IN will appear on-screen and L will appear on the display panel of the VCR. To exit Line Input mode, use the CHANNEL Up/Down buttons to select a channel other than 00.

Automatic Channel Programming (cont'd) 13

Adding/Deleting Channels

1

Press the VCR button.

2

Press the MENU button to bring up the main menu display.

TO SELECT PUSH NO. SHOWN
1 PROGRAM
2 VCR SET UP
3 TUNER SET UP
4 INPUT SELECT
5 SET CLOCK
6 SET REMOTE LOCATOR
TO END PUSH EXIT

3

Press the Number 3 button to select TUNER SET UP.

TO SELECT PUSH NO. SHOWN
1 TV
2 CABLE TV (ON)
3 AUTO PROGRAMMING
4 ADD/DELETE CH
5 CH MEMORY REVIEW
6 TV STEREO (ON)
7 SECOND AUDIO
TO END PUSH EXIT

4

Press the Number 4 button to select ADD/DELETE CH.

SELECT CHANNEL NUMBER
CH --
TO END PUSH EXIT

5

Use the Number buttons to enter the channel number.

6

Within 15 seconds, press the Number 1 button to add that channel. Or, press the Number 2 button to delete that channel. Or, press the Number 3 button to enter another channel. Your choice will appear to the right of the channel number.

TO SELECT PUSH NUMBER
CH12 DELETED
1 ADD
2 DELETE
3 SELECT ANOTHER CH
TO END PUSH EXIT

7

Press the EXIT/STATUS button to exit. Programming of the channel you added or deleted will appear on-screen.

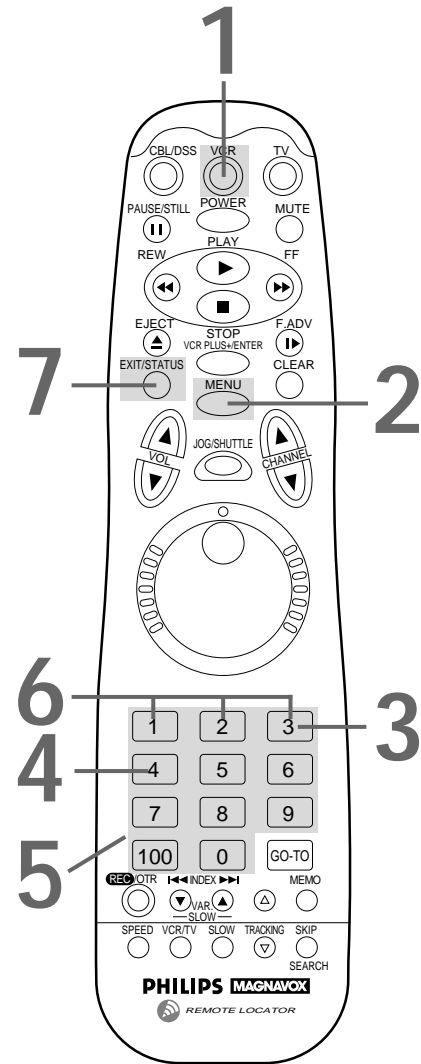

Helpful Hint

- To review the list of channels programmed by your VCR, follow these steps.
 - 1) Press the MENU button.
 - 2) Press the Number 3 button to select TUNER SET UP.
 - 3) Press the Number 5 button to select CH MEMORY REVIEW. If all the programmed channels don't fit on the screen, press the Number 1 button to see the next screen of channels. Then, press the Number 2 button to return to the previous screen of channels.
 - 4) Press the EXIT/STATUS button twice to exit.

14 Setting the Clock

There are four ways to set the VCR's clock: Manually, with Time Zone Selection, with Manual PBS Channel Selection, or with Automatic PBS Channel Selection. Cable Box/DSS Receiver users must set the clock manually. Before you set the clock, make sure:

- The VCR power is on.
- The VCR light appears on the display panel. If it does not, press the VCR/TV button once.
- Channels are programmed. *Details are on page 12.*
- You make each entry within one minute of the previous entry.

To set the clock manually, follow the steps on this page. To use Time Zone Selection, go to page 15. To use Manual PBS Channel Selection, go to page 16. To use Automatic PBS Channel Selection, go to page 17.

1

Press the VCR button, then press the MENU button.

2

Press the Number 5 button to select SET CLOCK. CABLE BOX USERS SET CLOCK MANUALLY will appear briefly.

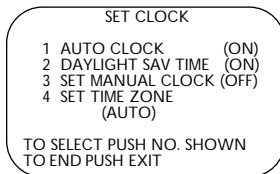

3

Press the Number 3 button to select SET MANUAL CLOCK.

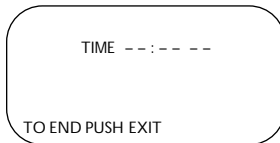

4

Press two Number buttons for the hour and two Number buttons for the minute(s). Then press 1 for AM or 2 for PM. For example, for 2:15 PM, press 02, 15, 2.

5

Press two Number buttons for the month, two Number buttons for the day, and two Number buttons for the year. For example, for July 1, 1997, press 07, 01, 97. The day of the week will appear automatically.

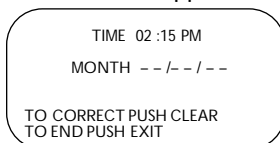

6

Press the EXIT/STATUS button.

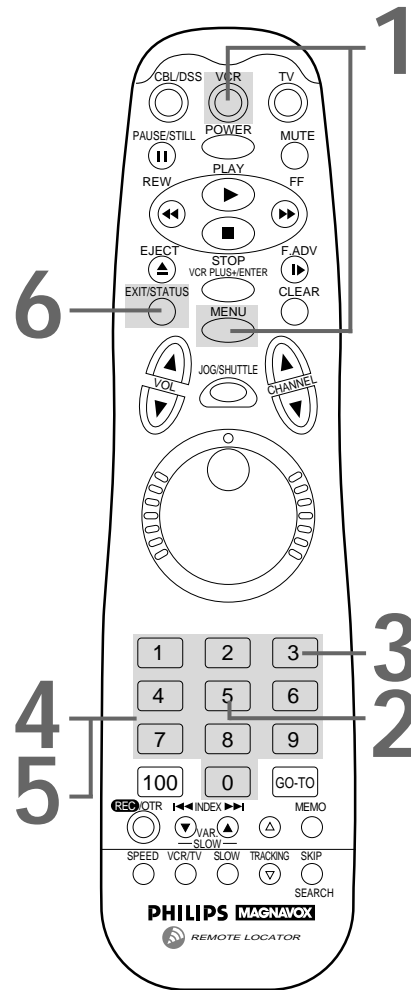

Helpful Hints

- If the numbers entered do not match the VCR's internal calendar, the entry will be rejected and a question mark (?) will appear on-screen.
- To program the VCR so its clock will automatically move forward one hour in April and turn back one hour in October, see page 18.
- Enter a 0 before single digit numbers.
- To make corrections, press the CLEAR button until the space for the number you want to correct is flashing. Then enter the correct number.

Setting the Clock (cont'd) 15

Time Zone Selection

1

Press the VCR button, then press the MENU button.

TO SELECT PUSH NO. SHOWN

- 1 PROGRAM
- 2 VCR SET UP
- 3 TUNER SET UP
- 4 INPUT SELECT
- 5 SET CLOCK
- 6 SET REMOTE LOCATOR

TO END PUSH EXIT

2

Press the Number 5 button to select SET CLOCK. CABLE BOX USERS SET CLOCK MANUALLY will appear on-screen briefly. Then, the menu shown below will appear.

(If AUTO CLOCK is set to OFF, SET TIME ZONE will not be available in the menu. If this happens, press the EXIT/STATUS button. Then, follow steps 1 - 3 on page 16. Press the EXIT/STATUS button, then start again at step 1 above.)

SET CLOCK

- 1 AUTO CLOCK (ON)
- 2 DAYLIGHT SAV TIME (ON)
- 3 SET MANUAL CLOCK (OFF)
- 4 SET TIME ZONE (AUTO)

TO SELECT PUSH NO. SHOWN
TO END PUSH EXIT

3

Press the Number 4 button to select SET TIME ZONE.

TO SELECT PUSH NO. SHOWN

- 1 AUTO (ON)
- 2 ATLANTIC
- 3 EASTERN
- 4 CENTRAL
- 5 MOUNTAIN
- 6 PACIFIC
- 7 ALASKA
- 8 HAWAII

TO CONTINUE PUSH MENU

4

Press a single Number button to enter the one-digit code for your Time Zone.

5

Press the MENU button, then press the EXIT/STATUS button.

6

Press the POWER button to turn off the VCR. Auto will flash in the display panel until the clock is set. Leave the VCR turned off until the time appears on the display panel.

If - - : - - appears on the display panel after you turn off the VCR, the VCR could not find the time. Set the clock following the steps on page 14.

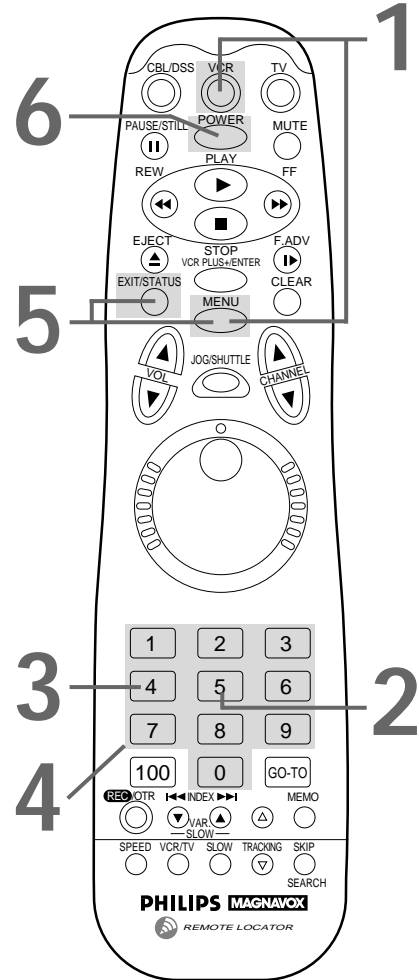

Helpful Hints

- When the power plug is connected to an AC outlet, the correct time will appear on the display panel of the VCR (when the power is off).
- If you live near the boundary of an adjacent time zone, your PBS channel may come from a different time zone. Select the time zone of your PBS channel at step 4.
- Cable Box/DSS Receiver users must set the clock manually. Details are on page 14.
- Press the EXIT/STATUS button repeatedly to make the time appear on the display panel when the VCR power is on.

16 Setting the Clock (cont'd)

Manual PBS Channel Selection

1

Press the VCR button, then press the MENU button.

2

Press the Number 5 button to select SET CLOCK. CABLE BOX USERS SET CLOCK MANUALLY will appear on-screen briefly. Then, the menu shown below will appear. (If AUTO CLOCK is set to OFF, SET TIME ZONE will not be available.)

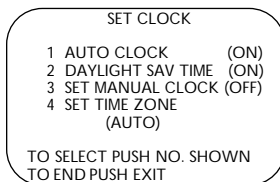

3

If (ON) appears to the right of AUTO CLOCK, press the Number 1 button twice. If (OFF) appears to the right of AUTO CLOCK, press the Number 1 button once.

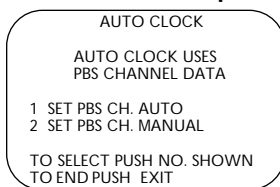

4

Press the Number 2 button to select SET PBS CH. MANUAL to tell the VCR the PBS channel from which to take the time.

5

Use the Number buttons to enter your PBS channel number. (If you make a mistake, press the CLEAR button.) Finally, press the EXIT/STATUS button.

6

The Time Zone Selection menu will appear. Press one Number button to enter the single-digit code for your Time Zone.

7

Press the EXIT/STATUS button. You will be prompted to turn off the VCR.

Press the EXIT/STATUS button again, then press the POWER button to turn off the VCR. Auto will flash in the display panel until the clock is set. Leave the VCR power off until the clock is set.

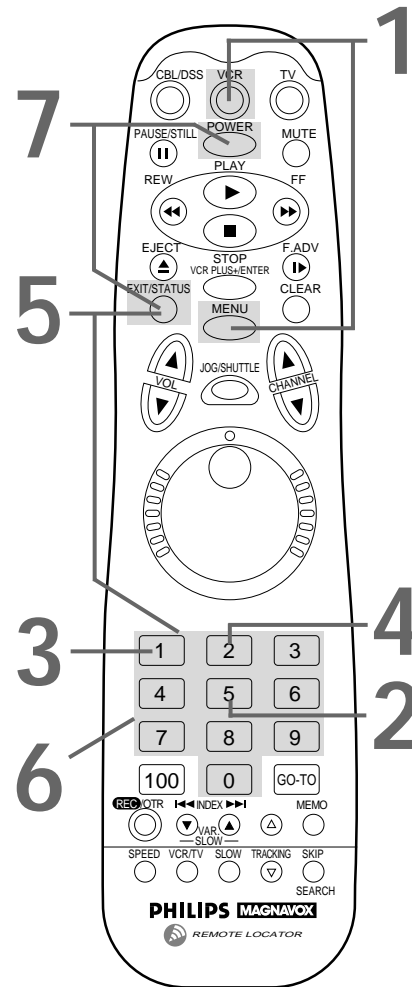

Helpful Hints

- The time will be updated at the top of each hour (except at 11 p.m., midnight, 1 a.m. and 2 a.m.).
- To see the time on the display panel, press the EXIT/STATUS button repeatedly.
- If - - : - - appears on the display panel after you turn off the VCR, the VCR could not find the time. Repeat steps 1 - 7 above, entering a different PBS channel at step 5. Or, set the clock following the steps on page 17.

Setting the Clock (cont'd) 17

Automatic PBS Channel Selection

1

Press the VCR button, then press the MENU button.

2

Press the Number 5 button to select SET CLOCK. CABLE BOX USERS SET CLOCK MANUALLY will appear on-screen briefly. Then, the menu shown below will appear. (If AUTO CLOCK is set to OFF, SET TIME ZONE will not be available.)

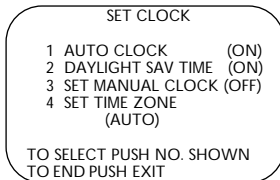

3

If (ON) appears to the right of AUTO CLOCK, press the Number 1 button twice. If (OFF) appears to the right of AUTO CLOCK, press the Number 1 button once.

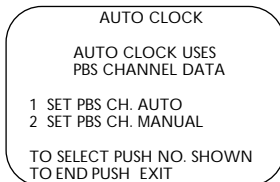

4

Press the Number 1 button to select SET PBS CH. AUTO to have the VCR find the PBS channel from which to take the time.

5

The Time Zone selection menu will appear. Press one Number button to enter the single-digit code for your Time Zone.

6

Press the EXIT/STATUS button. You will be prompted to turn off the VCR.

7

Press the EXIT/STATUS button, then press the POWER button to turn off the VCR.

Auto will flash in the display panel until the clock is set. Leave the VCR power off until the clock is set. If --:-- appears on the display panel after you turn off the VCR, the VCR could not find the time. You may need to tell the VCR the PBS channel from which to take the time. Follow the steps on page 16.

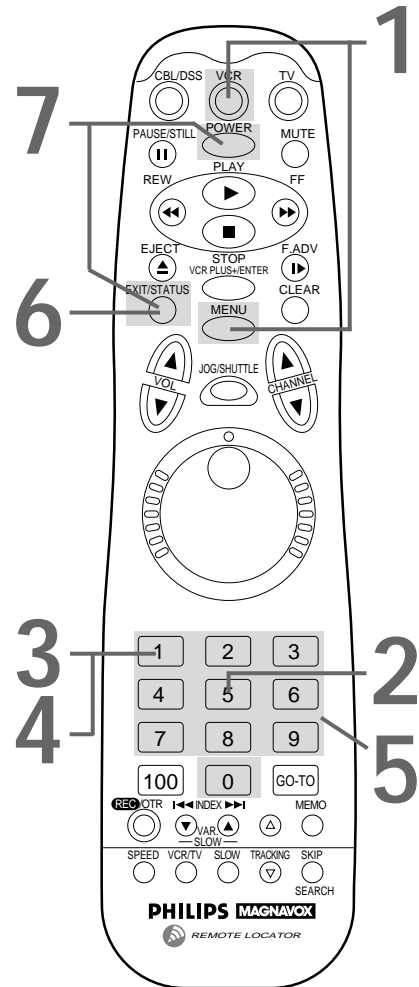

Helpful Hints

- The time will be updated at the top of each hour (except at 11 p.m., midnight, 1 a.m. and 2 a.m.).
- To display the time, press the EXIT/STATUS button. A status display will appear on the TV screen. (ON SCREEN OFF can not be the selected status display mode.) Details are on page 28.
- Power failures can cause you to lose your clock setting and programmed channels.

18 Daylight-Saving Time Selection

Daylight-Saving Time Selection

Follow the steps below to program the VCR so its clock will automatically move forward one hour in April and turn back one hour in October.

1

Press the **VCR** button, then press the **MENU** button to bring up the main menu display.

TO SELECT PUSH NO. SHOWN

- 1 PROGRAM
- 2 VCR SET UP
- 3 TUNER SET UP
- 4 INPUT SELECT
- 5 SET CLOCK
- 6 SET REMOTE LOCATOR

TO END PUSH EXIT

2

Press the **Number 5** button to select **SET CLOCK**. **CABLE BOX USERS SET CLOCK MANUALLY** will appear on-screen briefly. Then, the menu shown below will appear. (If **SET MANUAL CLOCK** is set to **(ON)**, **SET TIME ZONE** will not appear in the menu.)

SET CLOCK

- 1 AUTO CLOCK (ON)
- 2 DAYLIGHT SAV TIME (ON)
- 3 SET MANUAL CLOCK (OFF)
- 4 SET TIME ZONE (AUTO)

TO SELECT PUSH NO. SHOWN
TO END PUSH EXIT

3

Press the **Number 2** button so that **(ON)** appears to the right of **DAYLIGHT SAV TIME**.

Each time you press the **Number 2** button, you turn Daylight-Saving Time **ON** or **OFF**.

4

Press the **EXIT/STATUS** button to exit.

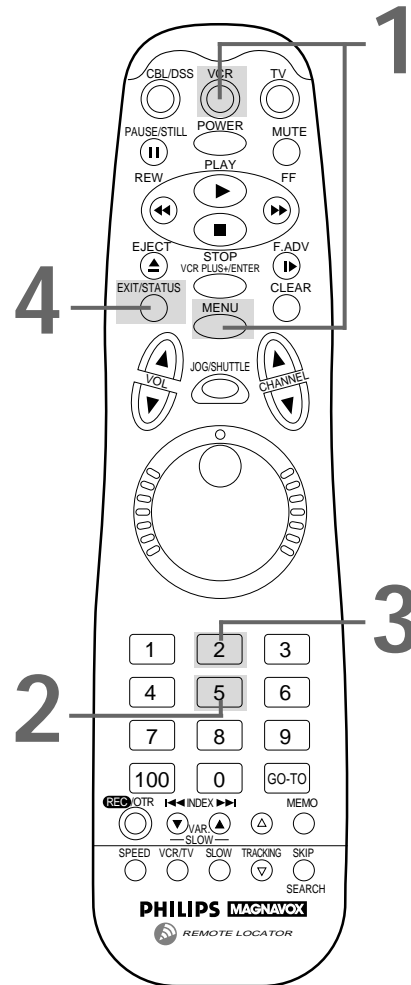

Helpful Hints

- To turn off Daylight-Saving Time, follow steps 1 - 2 above. At step 3, press the **Number 2** button so that **(OFF)** appears to the right of **DAYLIGHT SAV TIME**. Press the **EXIT/STATUS** button to exit.
- For more information about Daylight-Saving Time, please see page 61.

Language Selection 19

Language Selection

Follow the steps below to change the language of the on-screen displays.

1

Press the VCR button, then press the MENU button.

TO SELECT PUSH NO. SHOWN

- 1 PROGRAM
- 2 VCR SET UP
- 3 TUNER SET UP
- 4 INPUT SELECT
- 5 SET CLOCK
- 6 SET REMOTE LOCATOR

TO END PUSH EXIT

2

Press the Number 2 button to select VCR SET UP.

TO SELECT PUSH NO. SHOWN

- 1 SET REPEAT PLAY (OFF)
 - 2 ON SCREEN MODE
 - 3 LANGUAGE
 - 4 SET VCR PLUS+ CH
 - 5 SET CABLE BOX
 - 6 SET DSS RECEIVER
 - 7 AUDIO OUT
 - 8 VIDEO STABILIZER (OFF)
- TO END PUSH EXIT

3

Press the Number 3 button to select LANGUAGE.

TO SELECT PUSH NO. SHOWN

- 1 ENGLISH (ON)
- 2 ESPAÑOL

MAKE SELECTION OR
TO END PUSH EXIT

4

Press the Number 1 button if you want the on-screen displays in English. (ON) will appear to the right of ENGLISH on-screen.

Or, press the Number 2 button if you want the on-screen displays in Spanish. (SI) will appear to the right of ESPAÑOL on-screen.

TO SELECT PUSH NO. SHOWN

- 1 ENGLISH (ON)
- 2 ESPAÑOL

MAKE SELECTION OR
TO END PUSH EXIT

5

Press the EXIT/STATUS button to exit.

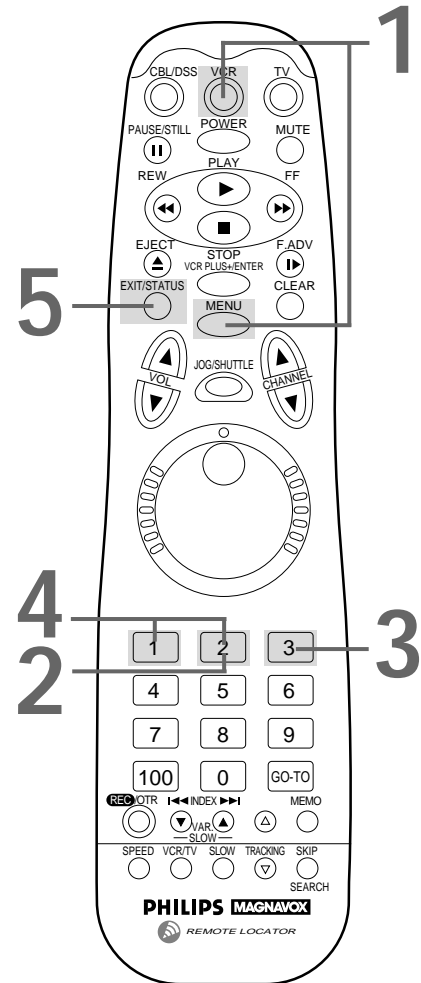

Helpful Hint

- If you accidentally select Spanish on-screen displays and need English on-screen displays, follow these steps.
1) Press the VCR button, then press the MENU button. 2) Press the Number 2 button to select PRE-PARE LA VCR. 3) Press the Number 3 button to select LENGUAJE. 4) Press the Number 1 button. (ON) will appear to the right of ENGLISH on-screen. 5) Press the EXIT/STATUS button.

20 Remote Control Buttons

VCR Button

Press this button before pressing VCR operation buttons.

CBL/DSS Button

Press this button before pressing Cable Box or DSS Receiver operation buttons.

PAUSE/STILL Button

When in Record mode, press to temporarily stop the recording (pause). Press a second time to resume normal recording. *Details are on page 31.* When in Play mode, press once to freeze the picture (still). Press a second time to resume normal playback.

Details are on page 56.

EXIT/STATUS Button

Press to exit on-screen menus. Press to bring up the status display for five seconds. *Details are on page 28.* When tape playback is stopped, press repeatedly to see the time, counter information, or channel number on the display panel. During tape playback, press repeatedly to see the time and counter information on the display panel. Or, if you have a Magnavox or Philips TV, press the TV button, then press the EXIT/STATUS button to access the TV on-screen displays or to exit the TV menu system.

VOL(ume) Up/Down Buttons
Press to increase or decrease the TV's volume.

REC(ord)/OTR Button

Press once to start a recording. *Details are on page 31.* Or, press repeatedly to start a one touch recording. *Details are on page 32.*

INDEX/ VAR.(iable) SLOW Buttons

When in Stop mode, press to search for index codes recorded on the tape. *Details are on page 48.* During slow motion playback, press to vary the playback speed. *Details are on page 56.*

TV Button

Press this button before pressing other TV operation buttons.

POWER Button

After pressing the CBL/DSS, VCR, or TV button, press to turn on or off the Cable Box/DSS Receiver, VCR, or TV.

MUTE Button

Press to eliminate the TV's sound. Press again to return to the previous volume.

VCR PLUS+/ENTER Button

Press to program a timer recording with the VCR Plus+ Programming System. *Details are on pages 40 - 41.*

MENU Button

Press to access the main VCR menu. If you have a Magnavox or Philips TV, press the TV button, then the MENU button, to access the TV menu system.

Number Buttons

After pressing the CBL/DSS, TV, or VCR button, press to select a channel at the Cable Box/DSS Receiver, TV, or VCR. Also, use to select VCR on-screen menus or to program VCR functions (such as setting the clock).

- Channels 1-9

To select, press 0, then the channel you want. For example, to select channel 7, press 0, 7.

- Channels 100 and above

To select, press the 100 button, then the last two digits of the channel you want. For example, to select channel 117, press the 100 button, 1, 7.

GO-TO Button

When tape playback is stopped, press to enter the tape counter location to which you want the tape to automatically fast forward or rewind. *Details are on page 53.*

SKIP SEARCH Button

Press during tape playback to skip 30 seconds of a tape. This feature will only work with tapes recorded in SP or SLP speed.

SLOW Button

During tape playback, press the SLOW button to view the picture in slow motion. Press again to resume normal playback. *Details are on page 56.*

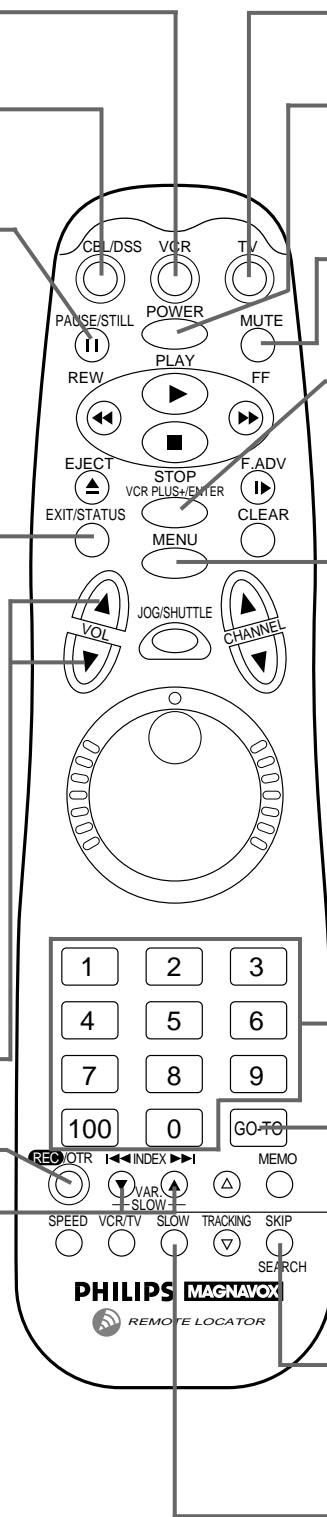

Remote Control Buttons (cont'd) 21

REW(ind) Button

When in Stop mode, press to rewind the tape at high speed. During tape playback, press to rewind the tape while the picture stays on-screen. *Details are on page 56.* If you have a Magnavox or Philips TV, press to adjust (decrease) the picture controls.

STOP Button

Press to stop the tape. If you have a Magnavox or Philips TV, press to move down or backward one row or selection in the TV menu system.

EJECT Button

Press to eject the tape.

JOG/SHUTTLE Button

Press to use the Jog Dial or the Shuttle Ring.

Jog Dial

Turn this dial while in the Still mode for jog control. The tape moves backward or forward frame-by-frame at the speed with which the dial is turned. *For details, see page 56.*

Shuttle Ring

While in the Play or Still mode, turn this ring in either direction. The farther the ring is rotated, the faster the search speed. Releasing the ring stops the picture in the Still mode. *For details, see page 56.*

(Tape) SPEED Button

Press to select a recording speed (SP or SLP). *Details are on pages 31, 36, and 58.*

VCR/TV Button

Press to select the signal that your TV receives.

- VCR Position

Use to watch a tape, to watch a program while recording it, or to watch a TV broadcast using the CHANNEL Up/Down or Number buttons. The VCR light will appear on the display panel when the VCR is in VCR position.

- TV Position

Use to watch TV or to watch one program while recording another. *Details are on page 33.* The VCR light will not appear when the VCR is in TV position.

PLAY Button

In VCR mode, press to play a tape. Also, press to release Slow, Still, or Search mode and to return to normal playback. *Details are on page 56.* In TV mode, press to move up or forward one row or selection in the TV menu if you have a Magnavox or Philips TV.

FF (Fast Forward) Button

When in Stop mode, press to advance the tape at high speed. When in Play mode, press to advance the tape while the picture stays on-screen. *Details are on page 56.* Or, if you have a Magnavox or Philips TV, press to adjust (increase) the picture controls.

F.(rame) ADV(ance) Button

In Still mode, press to advance the picture one frame at a time. *Details are on page 56.*

CLEAR Button

Press to erase incorrect data when programming VCR functions. Also, press to reset the tape counter to 0:00:00. *Details are on page 52.*

CHANNEL Up/Down Buttons

After pressing the CBL/DSS, TV, or VCR button, press to scan through the channels of the Cable Box/DSS Receiver, TV, or VCR.

MEMO(ry) Button

Press to memorize a tape location at which the tape counter was set to 0:00:00. *Details are on page 52.*

TRACKING Buttons

When in Play or Slow mode, press to adjust the tracking. In Still mode, press to eliminate vertical jitter. *Details are on page 57.*

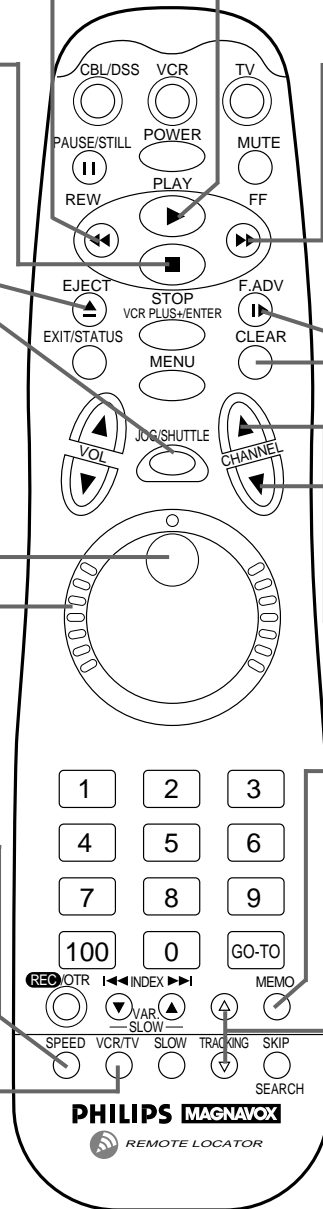

Helpful Hint

- This remote control may or may not operate your TV, Cable Box, or DSS Receiver. Or, it may only work some features of this equipment. See "Setting the Remote Control to Operate a TV" on page 26 and "Setting the Remote Control to Operate a Cable Box/DSS Receiver" on page 27 for details.

22 Display Panel

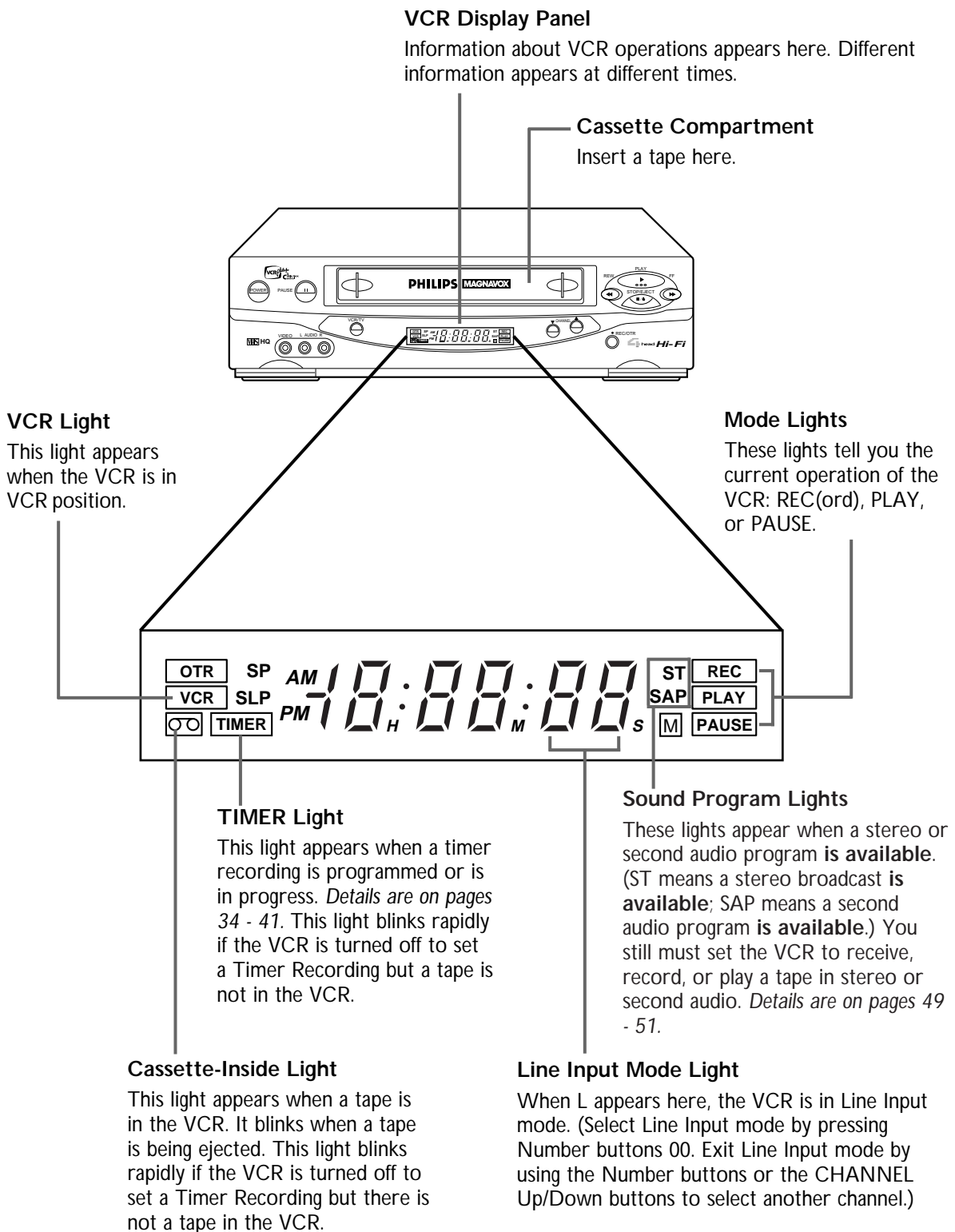

OTR Light

This light blinks when a one touch recording is in progress. *Details are on page 32.*

Remote Sensor

Receives a signal from your remote control so you can operate your VCR from a distance. Press the VCR button on the remote control before pressing other VCR operation buttons.

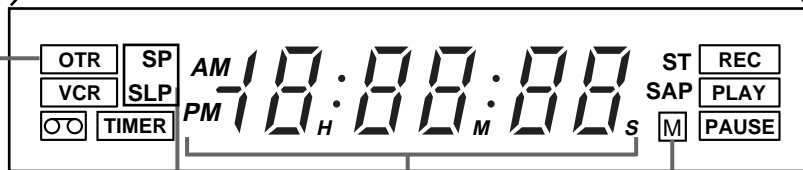
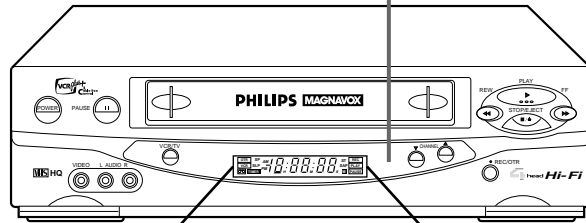

Tape Speed Lights

A tape speed light indicates the tape speed during recording and playback.

NOTE: Although this VCR will play tapes recorded in LP speed, LP will not appear on the display panel. This VCR will not record in LP speed. *Details on tape speeds are on pages 31, 36, and 58.*

Memory Light

This light appears when the tape counter has been reset to zero and memorized. *Details are on page 52.*

Clock/Counter/Channel Display

Each time you press the EXIT/STATUS button on the remote control, information on the VCR display panel will change. When tape playback is stopped, each press of the EXIT/STATUS button will cause the display panel to rotate between the following three displays: the current time (when the clock is set); the tape counter; and the channel number. During tape playback, each press of the EXIT/STATUS button will cause the display panel to alternate between the tape counter and the current time.

24 Front Panel

FF (Fast Forward) Button

When tape playback is stopped, press to fast forward the tape at high speed. During tape playback, press to fast forward the tape while the picture stays on-screen. *Details are on page 56.*

PLAY Button

Press to play a tape. Also, press to release Slow, Still, or Search mode and return to normal playback. *Details are on page 56.*

REW(ind) Button

When tape playback is stopped, press to rewind the tape at high speed. During tape playback, press to rewind the tape while the picture stays on-screen. *Details are on page 56.*

POWER Button

Press to turn the VCR power on and off. When you press the POWER button to turn on the VCR, you activate the Remote Locator feature. *Details are on page 29.*

PAUSE Button

During tape playback, press once to freeze the picture (Still). Press again to resume normal playback. *Details are on page 56.* During recording, press to temporarily stop the recording (Pause). Press a second time to resume recording. *Details are on page 31.*

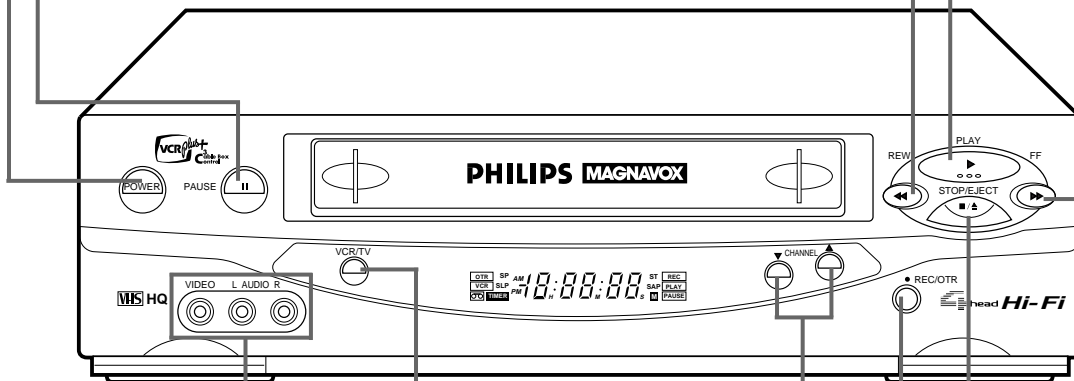

Front VIDEO/AUDIO IN Jacks

Connect cables coming from the VIDEO and AUDIO OUT Jacks of another VCR or a camcorder here. *Details are on page 47.*

CHANNEL Up/Down Buttons

Press to scan through the VCR's channels. During tape playback, press to manually adjust the tracking. *Details are on page 57.*

REC(ord)/OTR Button

Press once to record. *Details are on page 31.* Press repeatedly to start a One Touch Recording. *Details are on page 32.*

STOP/EJECT Button

Press once to stop the tape. When tape playback is stopped, press to eject the tape.

VCR/TV Button

Press to select the signal that your TV receives.

VCR Position:

Use to watch a tape, to watch a program while recording it, or to watch a TV broadcast using the CHANNEL Up/Down or Number buttons. The VCR light will appear on the display panel when the VCR is in VCR position.

TV Position:

Use to watch TV or to watch one program while recording another. *Details are on page 33.* The VCR light will not appear on the display panel when the VCR is in TV position.

Rear Panel 25

ANT(enna) IN Jack

Connect your antenna or cable here. *Details are on pages six - nine.*

AUDIO OUT Jacks

Connect cables going to the AUDIO IN jacks of a camcorder, another VCR, or an audio source here. *Details are on pages 47 and 50.*

CABLE BOX Jack

Connect the Controller here. You may use the Controller with either a Cable Box or a DSS Receiver. *Details are on pages 42 - 46.*

AUDIO IN Jacks

Connect cables coming from the AUDIO OUT jacks of a camcorder, another VCR, or an audio source here. *Details are on page 47.*

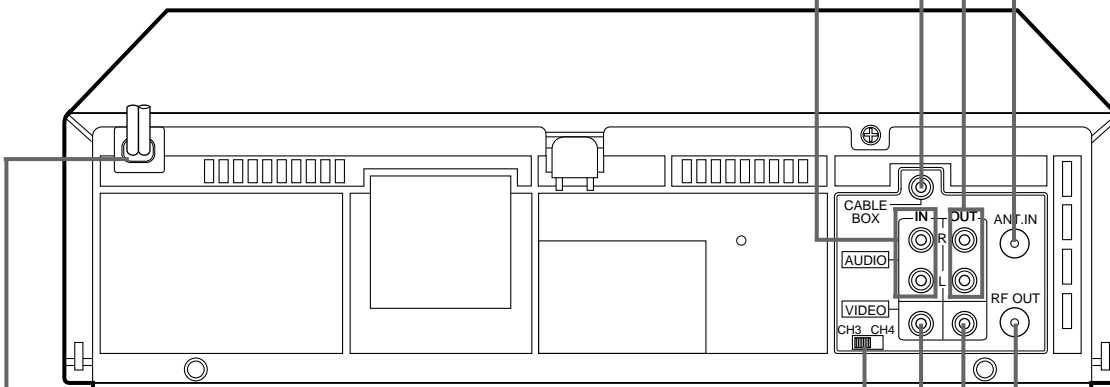

CH3/CH4 Switch

Set to channel 3 or 4 to use your TV with your VCR. Set your TV to the same channel. *Details are on pages six - nine.*

VIDEO IN Jack

Connect a cable coming from the VIDEO OUT jack of a camcorder or another VCR here. *Details are on page 47.*

VIDEO OUT Jack

Connect a cable going to the VIDEO IN jack of a camcorder or another VCR here. *Details are on pages 47 and 50.*

AC Power Cord

Connect to a wall outlet (120 V) to supply power to the VCR.

RF OUT Jack

Use the supplied RF coaxial cable to connect this jack to the ANTENNA IN Jack on your TV or to the IN Jack on your Cable Box or DSS Receiver (if applicable). *Details are on pages six - nine.*

26 Setting the Remote Control to Operate a TV

Your VCR remote control may operate your TV. Follow these steps to set the remote control code.

1

Point the remote control at your TV. Press the TV button, then press the POWER button. If your TV turns on or off, try the CHANNEL Up/Down buttons. If your TV doesn't turn on or off, or if the CHANNEL Up/Down buttons don't work, go to step 2. If your TV does work, you're finished.

2

Find the brand of your TV on the list below, and remember the two-digit number to the right of it.

TV CODES	
EMERSON	14
GOLDSTAR	04
HITACHI	12
JVC	05
MAGNAVOX	01, 02, 03
mitsubishi	13
PANASONIC	07, 17
PHILIPS	01
RCA	10
SAMSUNG	18
SANYO	11
SHARP	16
SONY	09
TOSHIBA	08
ZENITH	06, 15

3

Press the MUTE button, then press the TV button. Then use two Number buttons to enter the two-digit code for your TV. For example, if you have a Zenith TV, press Number buttons 1, 5.

4

Try step 1 again. If the remote control works your TV, you're finished. If the remote control still doesn't work your TV, repeat steps 2 - 3, using a different code.

There is no guarantee that the remote control will work your TV.

2 Find the code for your TV.

4 Repeat step 1.

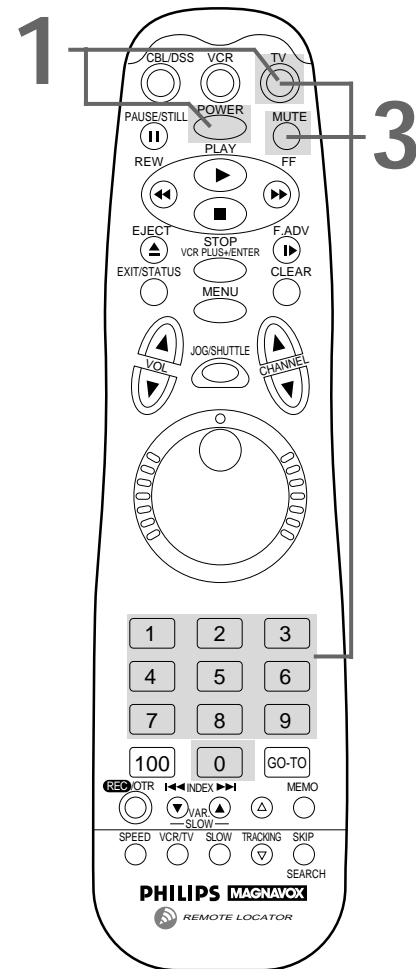

Helpful Hints

- If you had to program the remote control to operate your TV, whenever you replace the batteries in the remote control, you will have to program the remote control again.
- If you have a Philips TV or a Magnavox TV, you can use the remote control to operate other TV functions. Press the TV button before pressing other TV operation buttons. Details are on pages 20 - 21.

Setting the Remote Control to Operate a Cable Box/DSS Receiver 27

Your VCR remote control may operate your Cable Box or DSS Receiver. Follow these steps to set the remote control code.

1

Turn on the Cable Box/DSS Receiver. Point the remote control at your Cable Box/DSS Receiver. Press the **CBL/DSS** button, then the **POWER** button. If your Cable Box/DSS Receiver turns off, try the CHANNEL Up/Down buttons. If your Cable Box/DSS Receiver does not turn off, or if the CHANNEL Up/Down buttons don't work, go to step 2.

2

Find the brand of your Cable Box/DSS Receiver on the list below and remember the two-digit number to the right of it.

CABLE BOX/DSS RECEIVER CODES	
GENERAL INSTRUMENTS . . .	01, 02, 03, 04, 05, 06, 07
HAMLIN	21, 22
JERROLD	01, 02, 03, 04, 05, 06, 07
OAK	16, 17, 18
PANASONIC	19, 20
PIONEER	11, 12
SCIENTIFIC ATLANTA	08, 09, 10
TOCOM	23, 24, 25
ZENITH	13, 14, 15
MAGNAVOX DSS	42, 43
RCA DSS	40, 44
SONY DSS	41

3

Press the **MUTE** button, then press the **CBL/DSS** button. Use two **Number** buttons to enter the two-digit code for your Cable Box or DSS Receiver. For example, if you have a Zenith Cable Box, press Number buttons 1, 3.

4

Try step 1 again. If the remote control works your Cable Box or DSS Receiver, you're finished. If the remote control still does not work your Cable Box or DSS Receiver, repeat steps 2 - 3 using a different code.

There is no guarantee that the remote control will operate your Cable Box or DSS Receiver.

2

Find the code for your Cable Box/DSS Receiver.

4

Repeat step 1.

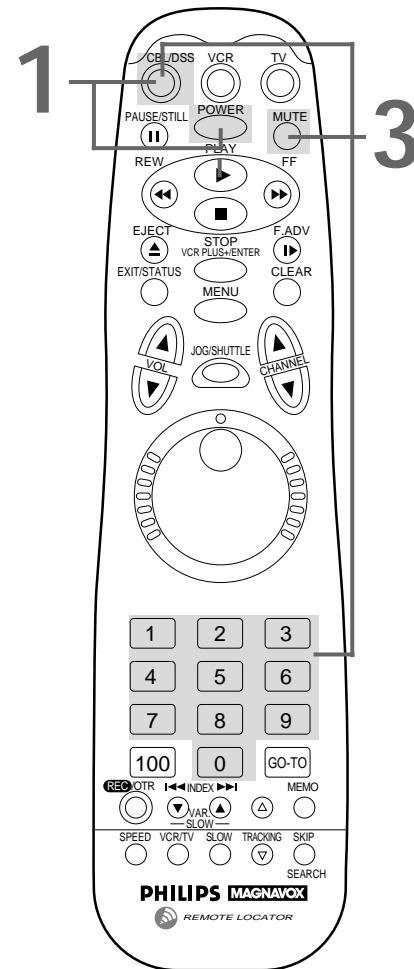

- ### Helpful Hints
- If you had to program the remote control to operate your Cable Box or DSS Receiver, whenever you replace the batteries in the remote control, you must program the remote control again.
 - The remote control may only operate some features of your Cable Box or DSS Receiver.
 - Some Cable Boxes/DSS Receivers can only be turned on at the Cable Box/DSS Receiver.

28 On-Screen Status Displays

An on-screen status display, which includes the current time, channel, and other information (see illustration of the status display at right), will appear when you press the EXIT/STATUS button or certain function buttons. The contents of the status display may vary.

ON SCREEN ON:

- Whenever you press the PLAY button or the STOP button, some of the contents of the status display will appear for five seconds.

COUNTER ONLY:

- The tape counter will appear on-screen at all times (except in Search, Slow or Still mode). Whenever you press the PLAY button or the STOP button, some of the contents of the status display will appear for five seconds. After five seconds, only the counter will remain on the screen.

ON SCREEN OFF:

- No status display will appear when you press function buttons or the EXIT/STATUS button.

To select one of the status display modes, follow these steps.

1

Press the VCR button, then press the MENU button.

2

Press the Number 2 button to select VCR SET UP.

TO SELECT PUSH NO. SHOWN
 1 SET REPEAT PLAY (OFF)
 2 ON SCREEN MODE
 3 LANGUAGE
 4 SET VCR PLUS+ CH
 5 SET CABLE BOX
 6 SET DSS RECEIVER
 7 AUDIO OUT
 8 VIDEO STABILIZER (OFF)
 TO END PUSH EXIT

3

Press the Number 2 button to select ON SCREEN MODE.

TO SELECT PUSH NO. SHOWN
 1 ON SCREEN ON (ON)
 2 COUNTER ONLY
 3 ON SCREEN OFF

TO END PUSH EXIT

4

Press the Number 1 button to select ON SCREEN ON, the Number 2 button to select COUNTER ONLY, or the Number 3 button to select ON SCREEN OFF. (ON) will appear beside the selected status display mode.

5

Press the EXIT/STATUS button to exit.

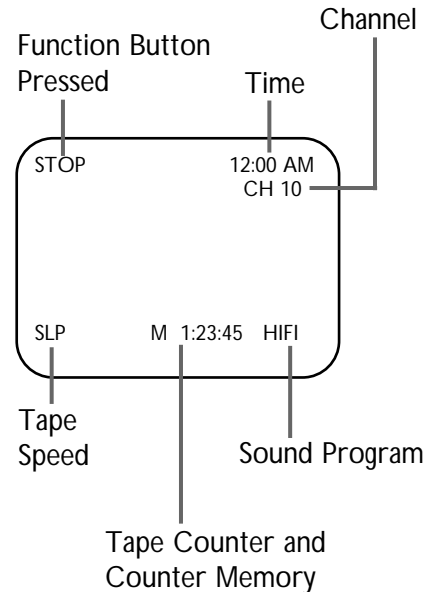

Helpful Hints

- In On Screen On and Counter Only modes:
 - You may bring up the status display at any time by pressing the EXIT/STATUS button. (The exception is during Slow, Search, or Still mode.) The display will appear for about five seconds.
 - Channel numbers (when tuned) will appear for a few seconds.
- When tape playback is stopped, press the EXIT/STATUS button to see the time, counter information, or channel number on the display panel. During tape playback, press the EXIT/STATUS button to see the time or counter information on the display panel. The channel will not appear.

Remote Locator 29

When you use the Remote Locator feature, your VCR can find your remote control. To find your remote, follow these steps.

1

Press the **POWER** button on the VCR. LOCATING REMOTE appears on the TV screen briefly. Within a few seconds, the remote control will start beeping. It will beep for about 30 seconds.

2

When you find the remote control, **point the remote at the VCR's remote sensor and press any button on the remote control to stop the beeping.**

The VCR may find other remote controls in your home, or even in an apartment complex. To program the VCR to find its remote control only, follow these steps.

1

Press the **VCR** button, then press the **MENU** button.

2

Press the **Number 6** button to select SET REMOTE LOCATOR.

TO CHANGE CODE,
PUSH MUTE AND PAUSE KEY
FOR 3 SECONDS.

TO END PUSH EXIT

3

Press and hold the **MUTE** button and the **PAUSE/STILL** button at the same time for three seconds. The current remote locator code will appear on-screen.

SET LOCATOR CODE
REMOTE LOCATOR CODE IS 4

TO SELECT PUSH 0-9

4

Press one **Number** button (**0 - 9**) on the remote control to set a new locator code. (If you press any other button, the code won't be set.) The remote control will beep briefly, indicating that the locator code has been changed successfully. The new code will appear in the menu, then the menu will disappear.

SET LOCATOR CODE
REMOTE LOCATOR CODE
HAS BEEN CHANGED
NEW CODE IS 6

To program the VCR to find its remote control only....

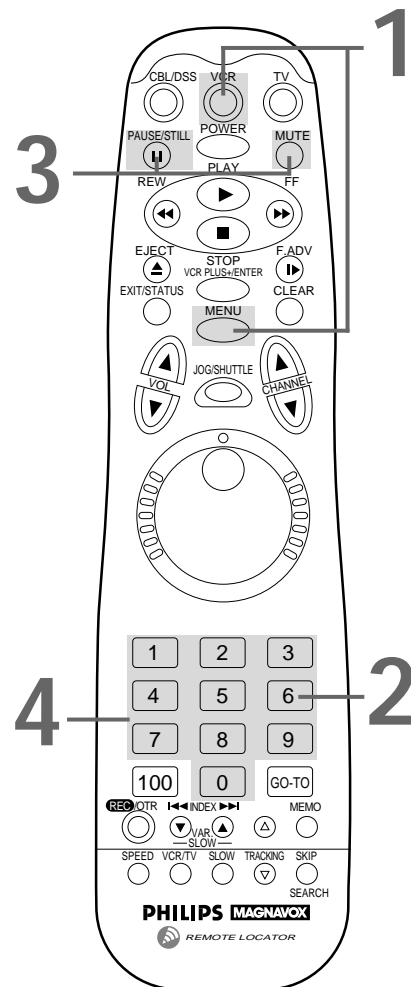

Helpful Hints

- The VCR may not find the remote control if the remote is placed on a metal shelf or on counter material.
- Any changes or modifications to the remote control not expressly approved by Philips Consumer Electronics Company could void the user's authority to operate the remote control.
- If you change the remote locator code in the steps above, you must reprogram the remote control when you replace the batteries.

30 Playing

Read and follow the steps below to play a tape.

1

Turn on the TV and set it to channel 3 or 4, whichever the CH3/CH4 switch on the back of the VCR is set to.

2

Insert a tape in the VCR. The power will come on. The VCR will place itself in VCR position automatically (the VCR light will appear on the display panel of the VCR). If the VCR light does not appear, press the VCR/TV button once. If the tape's record tab has been removed, playback will start automatically.

3

If playback does not start automatically, press the **PLAY** button. The PLAY light will appear on the VCR display panel.

4

Press the **STOP** button on the remote control or the **STOP/EJECT** button on the VCR once to stop playback.

5

Press the **REW(ind)** button to rewind the tape.

6

When the tape has finished rewinding, press the **EJECT** button on the remote control or the **STOP/EJECT** button on the VCR again to remove the tape.

1 Turn on the TV.

2 Insert a tape.

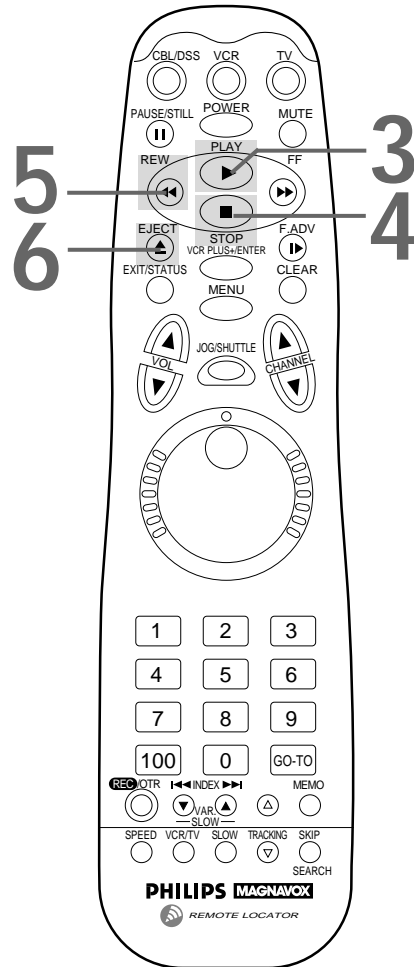

Helpful Hint

- Playback options and features are discussed on pages 49 - 57.

Recording 31

Read and follow the steps below to record a television program.

1

Turn on the TV and set it to channel 3 or 4, whichever the CH3/CH4 switch on the back of the VCR is set to.

2

Insert a tape with its record tab intact (details are on page five) in the VCR. The power will come on.

3

Press the VCR button.

4

If the VCR light appears on the display panel of the VCR, go to step 5. If the VCR light does not appear, press the VCR/TV button once.

5

Press the (Tape) SPEED button until the desired tape speed appears on-screen. The VCR will only record in SP or SLP. Details about tape speed are on pages 36 and 58.

6

Use the CHANNEL Up/Down buttons or the Number buttons to select the channel to be recorded.

7

Press the REC(ord)/OTR button to start recording. The REC(ord) light will appear on the VCR display panel. If the REC(ord)/OTR button is pressed while no tape is in the VCR, NO CASSETTE will appear on-screen for five seconds.

8

To pause the recording (for example, during commercials), press the PAUSE/STILL button. The PAUSE light will appear on the display panel.

To resume recording, press the PAUSE/STILL button again. The PAUSE light will disappear from the display panel.

9

Press the STOP button to stop recording. The REC(ord) light will disappear from the display panel.

1 Turn on the TV.

2 Insert a tape.

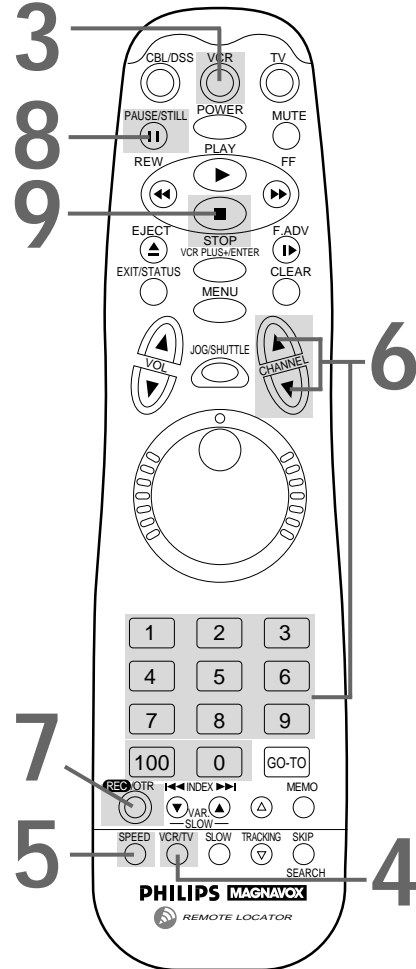

Helpful Hints

- If the REC(ord)/OTR button is pressed while a tape without a record tab is in the VCR, PROTECTED CASSETTE CANNOT RECORD will appear on-screen briefly. The VCR will eject the tape.
- You can change the tape speed while recording, but some distortion will appear on the tape.
- The VCR records in a preset volume.
- If the end of the tape is reached while recording, the VCR will stop recording, rewind the tape, then stop. Details are on page 57.

32 One Touch Recording

The one touch recording (OTR) function allows you to start an immediate timed recording 30 minutes to nine hours long of the channel you are watching. Before you begin, make sure:

- Channels are programmed. *Details are on page 12.*
- The desired recording speed (SP or SLP) has been selected with the (Tape) SPEED button. *Details are on pages 36 and 58.*
- There is a tape in the VCR. Make sure the tape's record tab is intact (see page five) and the tape is long enough to record the program(s). If the end of the tape is reached during an OTR, recording will stop. The VCR will eject the tape and turn itself off.
- The VCR is in VCR position. (The VCR light will appear on the display panel of the VCR when the VCR is in VCR position. If the VCR light does not appear, press the VCR/TV button once.)

Starting an OTR

1

Press the VCR button.

2

Use the CHANNEL Up/Down buttons or the Number buttons to select the channel you want to record.

3

Press the REC(ord)/OTR button 2 - 19 times, until the desired recording length (30 minutes to nine hours) appears in the upper left corner of the screen and on the display panel briefly. The OTR light will flash on the display panel; the REC(ord) light will appear on the display panel.

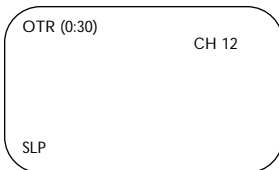

Stopping an OTR

To stop an OTR before recording is finished, press the STOP button.

To cancel the OTR but continue recording, press the REC(ord)/OTR button until REC appears in the upper left corner of the TV screen. The REC(ord) light will remain on the display panel, but the OTR light will disappear.

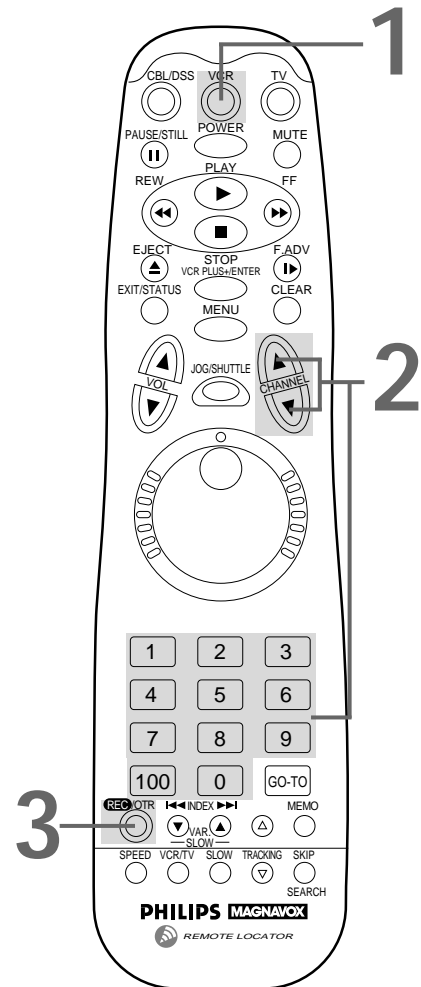

Helpful Hints

- To check the time remaining for an OTR after the OTR is in progress, press the EXIT/STATUS button.
- To change the recording length while an OTR is in progress, press the REC(ord)/OTR button until the desired length appears on-screen.
- If the preset time for a timer recording comes up during an OTR, the OTR has priority.
- You may not be able to access the menu during an OTR.

Recording One Channel/Watching Another 33

1

Press the VCR button.

2

Press the REC(ord)/OTR button to start a recording.

Details are on page 31.

3

Press the VCR/TV button to put the VCR in TV position. The VCR light will disappear from the display panel.

4

Use the TV remote control to select the channel you want to watch. Or, if the VCR remote control operates your TV, press the TV button, then use the CHANNEL Up/Down buttons or the Number buttons to select the channel you want to watch.

The channel selected with the TV controls will appear on-screen while the channel you previously selected to record is being recorded. (The REC(ord) light will appear on the display panel.)

5

To return to the channel being recorded, use the TV remote control to select channel 03 or 04 (whichever channel the CH3/CH4 switch on the back of the VCR is set to).

Or, if the VCR remote control operates your TV, press the TV button, then use the CHANNEL Up/Down buttons or the Number buttons to select channel 03 or 04.

6

Press the VCR button.

7

Press the VCR/TV button to put the VCR in VCR position. (The VCR light will appear on the display panel.) The channel being recorded will appear on-screen.

8

To stop the recording at any time, press the STOP button.

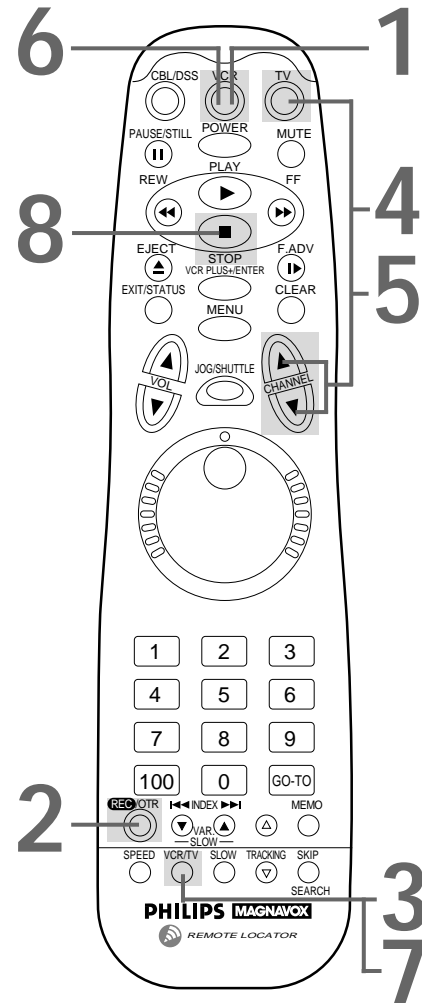

Helpful Hints

- If you use a Cable Box or DSS Receiver, you may not be able to watch one channel while recording another. See pages eight - nine for details.
- If your VCR remote control operates your TV, press the TV button, then use the CHANNEL Up/Down buttons or the Number buttons on the VCR remote control to select TV channels. Details are on page 26.
- If you don't receive channels, check your hookups, then follow these instructions carefully.

34 Timer Recording

Follow the steps below to program your VCR to record TV programs while you're away from home. You can program up to eight timer recordings. For each one, the VCR will turn itself on, record, and turn itself off automatically.

Before you begin make sure:

- Channels are programmed. *Details are on page 12.*
- The clock is set. *Details are on pages 14 - 17.*
- There is a tape in the VCR. Make sure the tape's record tab is intact and the tape is long enough to record the program(s).
- The VCR is in VCR position. The VCR light will appear on the display panel of the VCR when the VCR is in VCR position. If the VCR light does not appear, press the VCR/TV button once.
- When you use a Cable Box or DSS Receiver, timer recordings are programmed differently. Please read the information on page eight before proceeding.

Complete each step within 60 seconds of completing the previous step. If you don't, you may start again at step 1.

1

Press the VCR button, then press the MENU button.

TO SELECT PUSH NO. SHOWN

- 1 PROGRAM
- 2 VCR SET UP
- 3 TUNER SET UP
- 4 INPUT SELECT
- 5 SET CLOCK
- 6 SET REMOTE LOCATOR

TO END PUSH EXIT

2

Press the Number 1 button to select PROGRAM.

TO SELECT PUSH NO. SHOWN

- 1 ONCE
- 2 DAILY
- 3 WEEKLY
- 4 PROGRAM REVIEW

TO END PUSH EXIT

3

Select a once, daily, or weekly recording.

- Press the Number 1 button to select ONCE. The VCR will record a TV program on any day you choose, up to 12 months away.
- Press the Number 2 button to select DAILY. The VCR will record a program every day from Monday through Friday, starting at the same time and recording for the same length of time.
- Press the Number 3 button to select WEEKLY. The VCR will record on the same day, at the same time, and for the same length of time every week.

DAILY PROGRAM (MON-FRI)
PROGRAM - 12345678 -

**Daily
Recording
Menu
Screen**

SELECT PROGRAM NUMBER
TO END PUSH EXIT

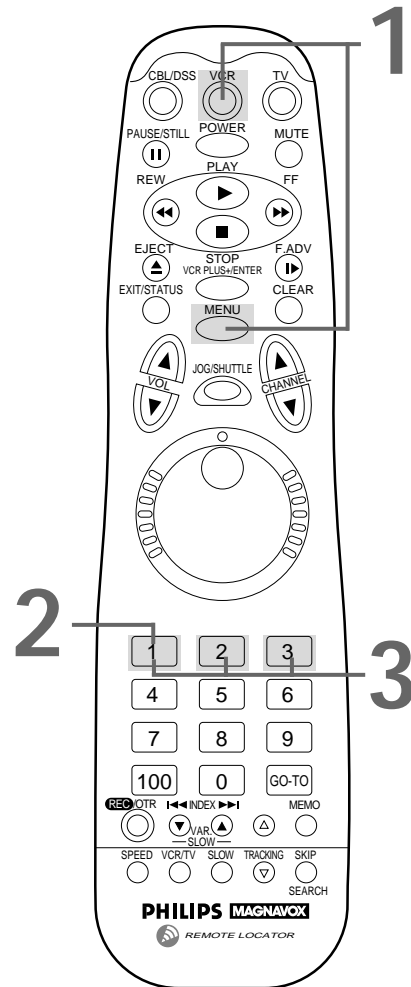

Helpful Hints

- To make corrections while you are programming a timer recording, press the CLEAR button until the cursor is flashing on the item you want to change. Enter the correct information.
- Leave the Cable Box or DSS Receiver on for a timer recording (if applicable). See page eight for details.
- Entries that do not match the VCR's internal calendar will cause a question mark to appear on-screen (for example, if you enter a Saturday date for a DAILY recording). Enter the correct information.

4

Use the Number buttons (1 - 8) to select a slot in which to store the timer recording. Flashing numbers indicate an open slot (one in which a timer recording has not yet been stored).

NOTE: If you select a number that has already been used to store a timer recording, PREVIOUSLY SET PROGRAM will appear on-screen briefly. Then information about the program in that slot will appear. If this happens, press the EXIT/STATUS button. Start again at step 1.

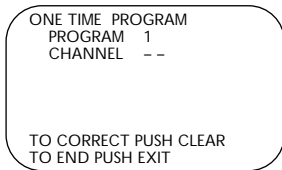

5

Use the Number buttons to enter the channel you want to record.

- If you are using a standard antenna or cable to VCR to TV hookup (as shown on pages six - seven), enter the channel of the TV program you want to record.
- If you are recording from line input, press 0, 0. A/V REAR will appear on-screen.
- If you are using a Cable Box/DSS Receiver, enter the output channel of your Cable Box/DSS Receiver (03 or 04). Leave the Cable Box/DSS Receiver on. Details are on pages eight and 58.
- If you are using the Controller, enter the Cable Box/DSS Receiver channel that you want to record. Leave the Cable Box/DSS Receiver on.

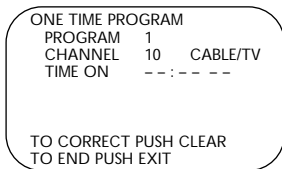

6

Press two Number buttons for the hour you want the recording to begin. Press two Number buttons for the minute(s) you want the recording to begin. Press 1 for AM or 2 for PM. For example, for 9:30 PM, press 09, 30, 2.

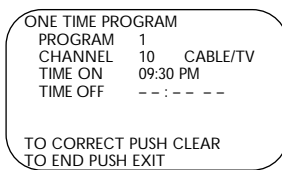

7

Follow step 6 to set the recording's stop time.

Instructions continue on page 36.

4-7

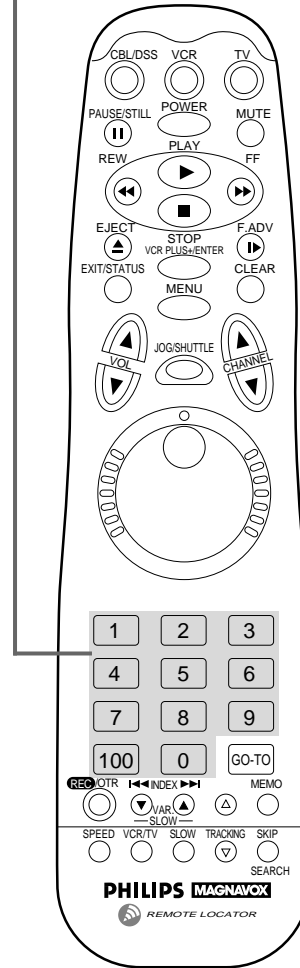

Helpful Hints

- If the preset time for a timer recording comes up during a One Touch Recording, the OTR has priority.
- If you leave the VCR on past the scheduled start time of a timer recording, you will not be prompted by the VCR again to turn off the VCR. When you turn off the VCR, the timer recording will not take place.
- If the end of the tape is reached during a Timer Recording, recording will stop. The VCR will eject the tape, then turn itself off.

36 Timer Recording (cont'd)

8

Press the Number 1 button to record in SP speed. Press the Number 2 button to record in SLP speed. You cannot use the (Tape) SPEED button at this time.

ONE TIME PROGRAM
 PROGRAM 1
 CHANNEL 10 CABLE/TV
 TIME ON 09:30 PM
 TIME OFF 11:00 PM
 REC SPEED SLP
 SP=1 SLP=2
 TO CORRECT PUSH CLEAR
 TO END PUSH EXIT

9

Press two Number buttons for the month and two Number buttons for the day you want the program to record. For example, for July 10, press 07, 10. The day of the week and the year will appear automatically. (You cannot program the VCR to record more than one year in advance.)

ONE TIME PROGRAM
 PROGRAM 1
 CHANNEL 10 CABLE/TV
 TIME ON 09:30 PM
 TIME OFF 11:00 PM
 REC SPEED SLP
 START DATE 07/10/97
 THU.
 TO CORRECT PUSH CLEAR
 TO END PUSH EXIT

10

Press the EXIT/STATUS button. PROGRAM WAS COMPLETED/PLEASE TURN OFF VCR FOR TIMER RECORDING will appear on-screen. In three seconds, the message will disappear. (If PROGRAM NOT COMPLETED appears, try again from step 1. If PROGRAM NOT COMPLETED/CLASH appears, the timer recording you just programmed overlaps with an earlier timer recording. The timer recording you just programmed will not take place.)

11

Press the POWER button to turn off the VCR. The TIMER light will appear on the display panel. (The TIMER light and the Cassette-Inside light will flash if there is not a tape in the VCR.) The VCR must be turned off for a timer recording to take place. If you forget to turn off the VCR, PLEASE TURN OFF VCR FOR TIMER RECORDING flashes on your TV screen two minutes before a timer recording starts. To remove the message, press the CLEAR button.

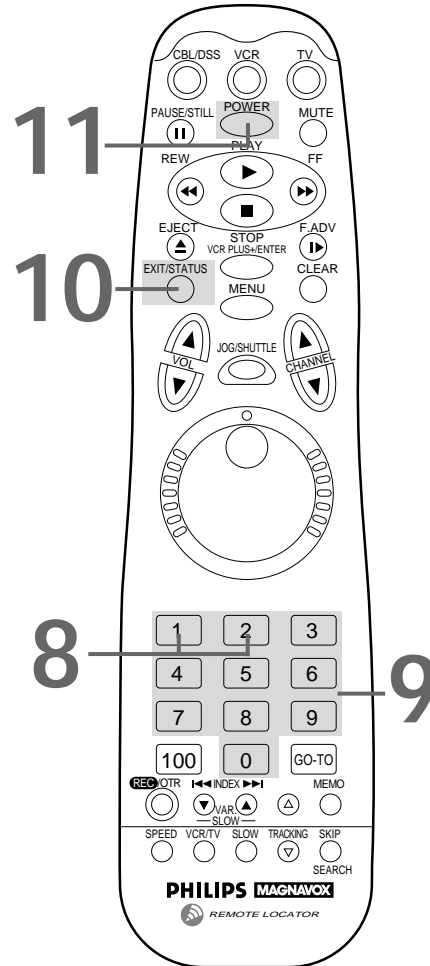

The VCR must be off for a timer recording to occur. Make sure the VCR has a tape.

Tape Speeds	Tape Speed	Maximum Record/Playback Time		
		T160	T120	T60
This chart shows the recording/playback time for T160, T120, and T60 video cassettes. There are three playback speeds: SP, LP, and SLP. This VCR will play tapes recorded in LP, but LP will not appear on the display panel. This VCR will only record in SP and SLP.	SP (Standard Play)	2 hrs. 40 mins.	2 hrs.	1 hr.
	LP (Long Play)	5 hrs. 20 mins.	4 hrs.	2 hrs.
	SLP (Super Long Play)	8 hrs.	6 hrs.	3 hrs.

Checking or Clearing Timer Recordings

1

Press the **VCR** button.

2

Make sure the VCR is in VCR position. (The VCR light will appear on the display panel.) **If the VCR light does not appear, press the VCR/TV button once.**

3

Press the **MENU** button.

4

Press the **Number 1** button to select **PROGRAM**.

5

Press the **Number 4** button to select **PROGRAM REVIEW**. The timer recording information for the program in the lowest numbered slot will appear on-screen. (If there are no timer recordings set, **NO PROGRAM SET** will appear briefly when you press the Number 4 button. Then, you will return to the previous screen. Press the **EXIT/STATUS** button to exit.)

6

Press the **Number 1** button repeatedly to review all programmed timer recordings. If you don't press the Number 1 button in 10 seconds, the VCR will automatically display information about the next programmed timer recording. This will continue until all filled slots have been displayed. Then, the previous menu will appear.

7

To cancel the timer recording currently displayed, press the **CLEAR** button. You will either see the next programmed timer recording or you will return to the previous menu.

8

Press the **EXIT/STATUS** button to exit.

9

Repeat steps 1 - 6 to make sure you have cleared the correct timer recording.

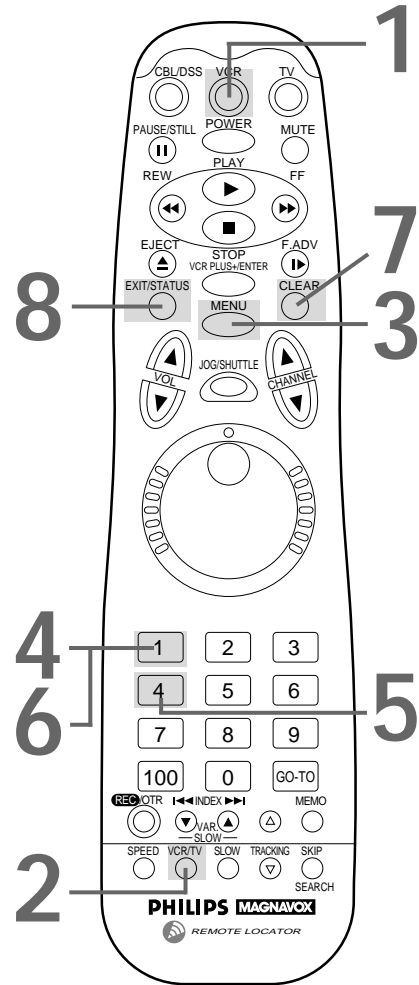

Helpful Hints

- To stop a started timer recording, press the **POWER** button.
- You can exit the Program Review at any time by pressing the **EXIT/STATUS** button.

See pages 60 -61 for more hints.

Setting Up the VCR Plus+ Programming System (cont'd) 39

2

Now, compare the channel numbers you have written into the VCR PLUS+ CH. and CABLE/TV CH. columns. You'll notice that some stations have VCR Plus+ and Cable/TV channel numbers that are the same, and other stations have channel numbers that do not match. Where the channel numbers DO NOT match, you must tell the VCR the VCR Plus+ and Cable/TV channel numbers according to the following steps.

3

Press the VCR button, then press the MENU button.

TO SELECT PUSH NO. SHOWN

- 1 PROGRAM
- 2 VCR SET UP
- 3 TUNER SET UP
- 4 INPUT SELECT
- 5 SET CLOCK
- 6 SET REMOTE LOCATOR

TO END PUSH EXIT

4

Press the Number 2 button to select VCR SET UP.

TO SELECT PUSH NO. SHOWN

- 1 SET REPEAT PLAY (OFF)
 - 2 ON SCREEN MODE
 - 3 LANGUAGE
 - 4 SET VCR PLUS+ CH
 - 5 SET CABLE BOX
 - 6 SET DSS RECEIVER
 - 7 AUDIO OUT
 - 8 VIDEO STABILIZER (OFF)
- TO END PUSH EXIT

5

Press the Number 4 button to select SET VCR PLUS+ CH.

6

Look at the columns you filled in on page 38. For stations whose VCR Plus+ and Cable/TV channels are not the same, use the CHANNEL Up/Down buttons to place the arrow beside the VCR PLUS+ channel. Then, press two Number buttons to enter the CABLE/TV channel. Entries must be made within one minute. If you enter the CABLE/TV channel incorrectly, you may enter it again.

Do this until you have entered all the channels on your list.

VCR PLUS+	CROSS REF. MAP	CABLE/TV
98		98
99		99
01	----->	33
02		02

TO SELECT CH PUSH CH UP/
DOWN, THEN ENTER CH. NO.
TO END PUSH EXIT

7

Press the EXIT/STATUS button to exit.

2 Examine the lists on page 38.

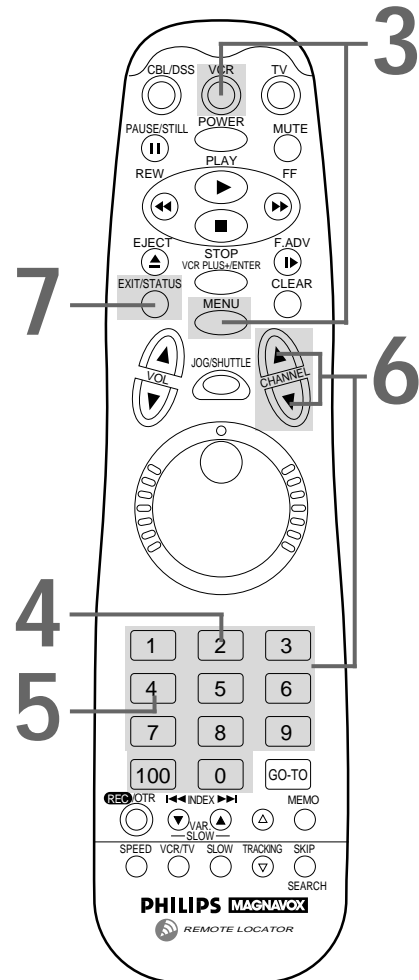

Helpful Hints

- To check the VCR PLUS+ and CABLE/TV channel listings, follow steps 3 - 5 above. A list of VCR PLUS+ and CABLE/TV channel numbers will appear on-screen. To move through the list, press the CHANNEL Up/Down buttons. Make sure these numbers match your lists on page 38. Press the EXIT/STATUS button to exit.
- When you receive the VCR from the factory, all the VCR Plus+ channel numbers and Cable/TV channel numbers are the same in the cross reference map.

40 Timer Recording With the VCR Plus+ Programming System

Follow the steps below to program a timer recording using PlusCode programming numbers. Before you begin make sure:

- Channels are programmed. *Details are on page 12.*
- The clock is set. *Details are on pages 14 - 17.*
- There is a tape in the VCR. Make sure the tape's record tab is intact and the tape is long enough to record the program(s).
- The VCR is in VCR position (the VCR light will appear on the display panel of the VCR). If the VCR light does not appear, press the VCR/TV button once.
- You have programmed the VCR+ and Cable/TV channel numbers. *Details are on pages 38 - 39.*

Complete each step within 60 seconds of completing the previous step. If you don't, you may start again at step 1.

1

Press the VCR button.

2

Press the VCR PLUS+/ENTER button. The on-screen display shown below will appear.

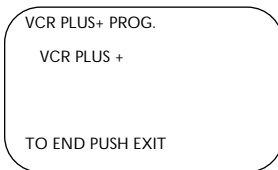

3

Use the Number buttons to enter the PlusCode programming number of the program you wish to record. (This number is different for every program, and it can be four to eight digits long.) **Finally, press the VCR PLUS+/ENTER button.**

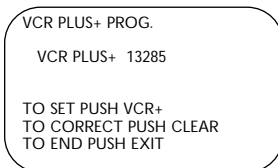

4

Select a ONCE, DAILY, or WEEKLY recording.

To record the program one time, press the Number 1 button to select ONCE. To record the same program every day from Monday through Friday, press the Number 2 button to select DAILY. To record the same program every week on the same day (such as every Saturday), press the Number 3 button to select WEEKLY.

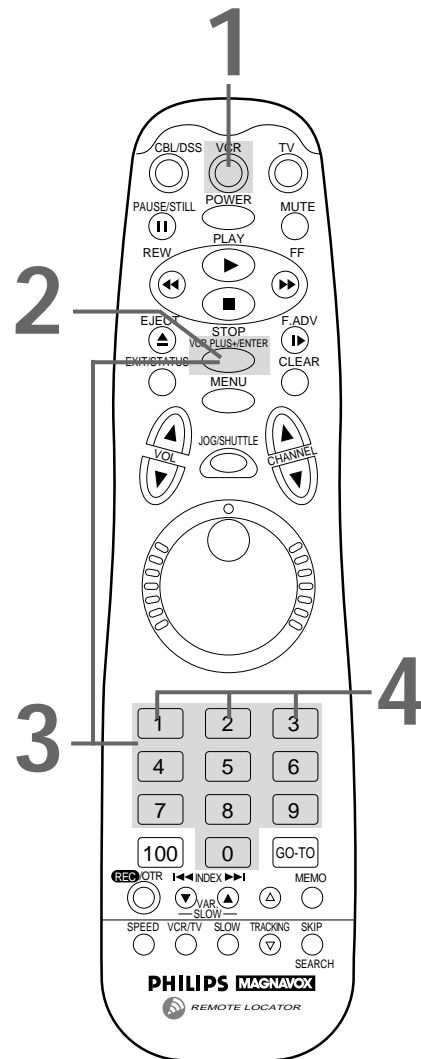
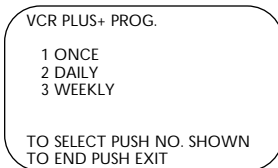

Helpful Hints

- If you enter an incorrect PlusCode programming number at step 3, ERROR will appear briefly, then the previous menu will appear. Enter the correct PlusCode programming number.
- If ERROR appears at step 4 when you select DAILY, the PlusCode programming number you entered is for a program that is broadcast on Saturday or Sunday. The program cannot be recorded repeatedly from Monday through Friday.

Timer Recording With the VCR Plus+ Programming System (cont'd) 41

5

Press the **Number 1** button to record in SP speed or the **Number 2** button to record in SLP speed. You cannot use the (Tape) SPEED button at this time.

ONE TIME PROGRAM
PROGRAM 2
CHANNEL 25 CABLE/TV
TIME ON 10:00 AM
TIME OFF 01:00 PM
REC SPEED SLP
START DATE 07/10/97
THU.
PUSH 1=SP OR 2=SLP
TO END PUSH EXIT

6

Press the **EXIT/STATUS** button. PROGRAM WAS COMPLETED/PLEASE TURN OFF VCR FOR TIMER RECORDING should appear on the screen. (If PROGRAM NOT COMPLETED appears, begin again from step 1.) After five seconds, the on-screen display will disappear.

7

Press the **POWER** button to turn off the VCR. The VCR must be turned off for a timer recording to take place. The TIMER light will appear on the display panel of the VCR when you turn off the VCR. The TIMER light and the Cassette-Inside light will flash if there is not a tape in the VCR.

**The VCR must be off for a timer recording to take place!
Make sure a tape is in the VCR.**

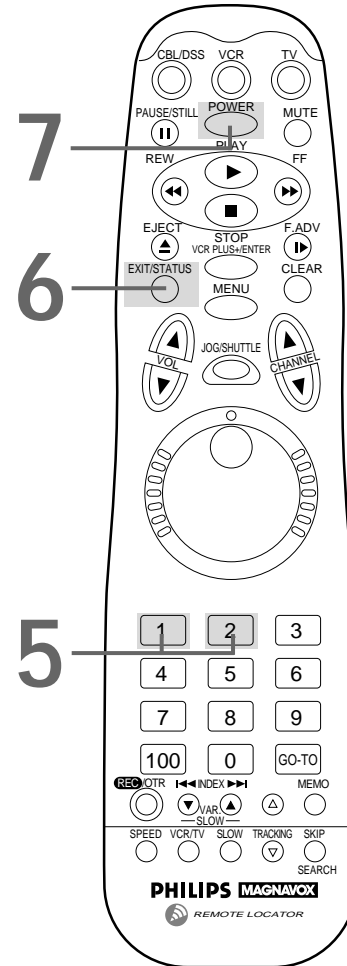

Helpful Hints

- To exit the VCR Plus+ programming system at any step, press the EXIT/STATUS button.
- PROGRAM NOT COMPLETED/CLASH may appear on-screen for five seconds at step 6 if the timer recording you programmed overlaps with another timer recording. Then, the timer recording menu will appear. To cancel the overlapping timer recording, follow the steps on page 37.

42 Connecting the Controller

If you are using a Cable Box or DSS Receiver, connect the Controller to your VCR. The Controller will automatically select channels at the Cable Box or DSS Receiver during a timer recording. Leave your Cable Box or DSS Receiver turned on during a timer recording.

1

Connect the Cable Box or DSS Receiver to the VCR as shown below. For more information, please read page eight. Or, refer to the owner's manual of your Cable Box or DSS Receiver.

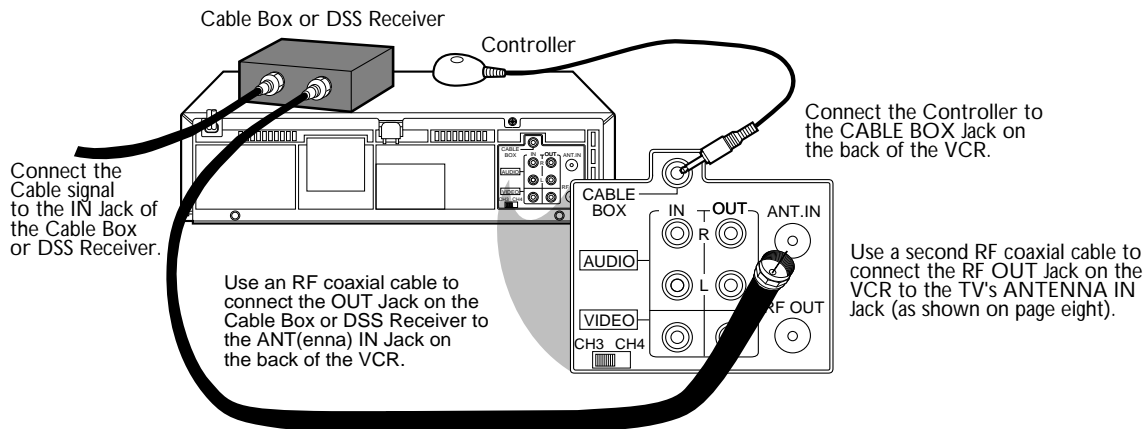

2

Connect the Controller to the CABLE BOX Jack on the back of the VCR as shown above.

3

Attach the Controller to the top of the VCR using adhesive tape. Make sure the Controller's transmitter (the light on the top of the Controller) is pointed toward the Cable Box or DSS Receiver's remote sensor.

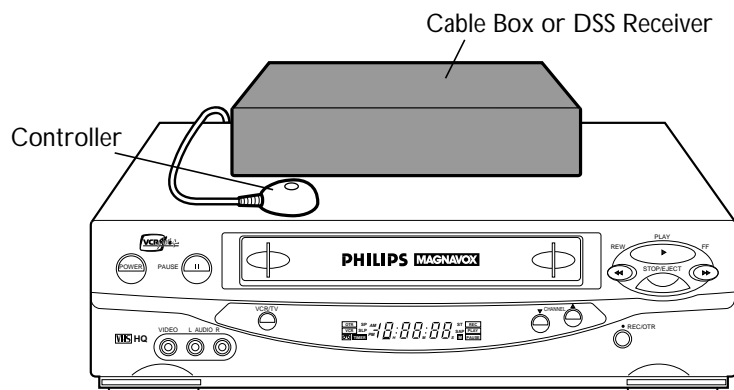

4

If you are using a Cable Box, follow the steps on pages 43 - 44 to make the Controller change channels at the Cable Box during timer recordings.

If you are using a DSS Receiver, follow the steps on pages 45 - 46 to make the Controller change channels at the DSS Receiver during timer recordings.

Setting the Controller to Operate a Cable Box 43

- If you use a Cable Box, you must set the clock manually. *Details are on page 14.*
- Complete the steps on page 27 before proceeding. This will enable you to use the VCR remote control to operate the Cable Box, and you will learn your Cable Box code.
- Make each entry within one minute of the previous entry.

1

Turn on the Cable Box. Select a channel other than 09.

2

Press the VCR button, then press the MENU button.

3

Press the Number 2 button to select VCR SET UP.

TO SELECT PUSH NO. SHOWN
 1 SET REPEAT PLAY (OFF)
 2 ON SCREEN MODE
 3 LANGUAGE
 4 SET VCR PLUS+ CH
 5 SET CABLE BOX
 6 SET DSS RECEIVER
 7 AUDIO OUT
 8 VIDEO STABILIZER (OFF)
 TO END PUSH EXIT

4

Press the Number 5 button to select SET CABLE BOX.

CABLE BOX CONTROLLER
 OFF
 TO SELECT PRESS NUMBER
 1 ON
 2 OFF
 TO CONTINUE PUSH MENU
 TO END PUSH EXIT

5

Press the Number 1 button to set the Cable Box Controller to ON.

CABLE BOX CONTROLLER
 ON
 TO SELECT PRESS NUMBER
 1 ON
 2 OFF
 TO CONTINUE PUSH MENU
 TO END PUSH EXIT

6

Press the MENU button. If CABLE BOX USERS SET CLOCK MANUALLY appears, follow steps 4 - 6 on page 14, then go to step 7 on page 44.

SELECT CODE NUMBER
 OF YOUR CABLE BOX
 ..
 TO END PUSH EXIT

Instructions continue on page 44.

1 Turn on the Cable Box. Set it to a channel other than channel 09.

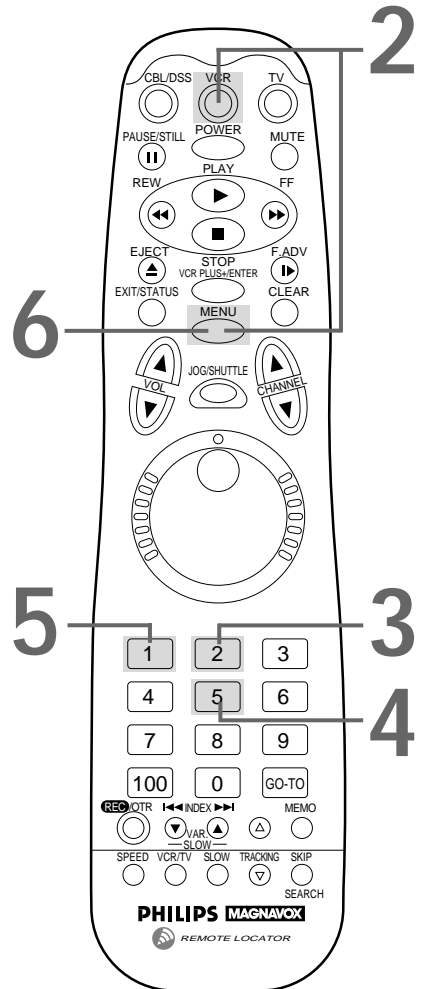

Helpful Hints

- If the EXIT/STATUS button is pressed during steps 6 - 9, "CABLE BOX CONTROL IS OFF" will appear on-screen for five seconds.
- If the remote control does not operate the Cable Box, the Controller will not change channels at the Cable Box during a timer recording. You must select the channel to be recorded at the Cable Box before a timer recording begins. Leave the Cable Box on. Enter the Cable Box output channel (03 or 04) at step 5 on page 35.

44 Setting the Controller to Operate a Cable Box (cont'd)

7

Use the **Number** buttons to enter the two-digit code for your **Cable Box**. (See list below.)

SELECT CODE NUMBER
OF YOUR CABLE BOX
02
TO TEST PUSH MENU
DID CABLE BOX CHANGE
TO CHANNEL 09?
1 YES 2 NO
TO END PUSH EXIT

CABLE BOX/DSS RECEIVER CODES	
GENERAL INSTRUMENTS01, 02, 03, 04, 05, 06, 07
HAMLIN21, 22
JERROLD01, 02, 03, 04, 05, 06, 07
OAK16, 17, 18
PANASONIC19, 20
PIONEER11, 12
SCIENTIFIC ATLANTA08, 09, 10
TOCOM23, 24, 25
ZENITH13, 14, 15
MAGNAVOX DSS Receiver42, 43
RCA DSS Receiver40
SONY DSS Receiver41

8

Press the **MENU** button. Wait for a few seconds.

- If the Cable Box changes to channel 09, go to step 9.
- If the Cable Box doesn't change to channel 09, press the Number 2 button to select NO. Use the Number buttons to enter a different code for your Cable Box. Press the MENU button. When the Cable Box changes to channel 09, go to step 9.

9

Press the Number 1 button to select YES.

10

A zero will appear in the **SELECT OUTPUT CH** menu. Press one Number button (3 or 4) to complete the output channel of your Cable Box (channel 03 or 04).

- Press 0 if you connected the VIDEO/AUDIO OUT Jacks of the Cable Box to the VCR's VIDEO/AUDIO IN Jacks. A/V CONNECT A/V REAR ONLY will appear.
- If you make a mistake, press the CLEAR button, then enter the correct output channel.

SELECT OUTPUT CH
OF YOUR CABLE BOX
03
TO CONTINUE PUSH MENU
TO CORRECT PUSH CLEAR
TO END PUSH EXIT

11

Press the **MENU** button or the **EXIT/STATUS** button. "CABLE BOX CONTROL IS ON" will appear for five seconds.

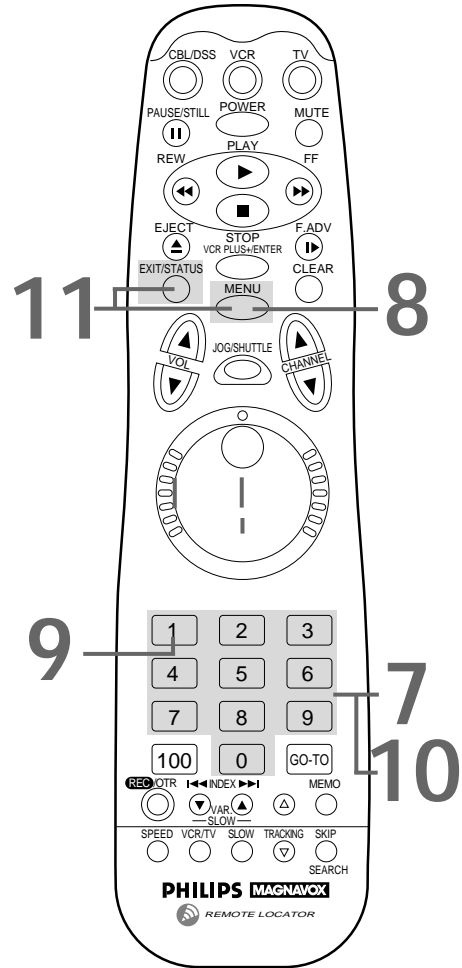

Helpful Hints
<ul style="list-style-type: none"> • If your Cable Box does not respond to any of the codes at step 8, the Controller will not change channels at the Cable Box during a timer recording. You must select the channel to be recorded at the Cable Box before a timer recording begins. Enter the Cable Box output channel (03 or 04) at step 5 on page 35. Leave the Cable Box on for the timer recording. See page eight for details. You may want to exchange your current Cable Box for one that can be controlled by the VCR's Controller. • The Controller can change channels at the Cable Box only during a timer recording.

Setting the Controller to Operate a DSS Receiver 45

- If you use a DSS Receiver, you must set the clock manually. *Details are on page 14.*
- Complete the steps on page 27 before proceeding. This will allow you to use the VCR remote control to operate the DSS Receiver, and you will learn your DSS Receiver code.

- 1** Turn on the DSS Receiver. Select a channel other than 205.

1
Turn on the DSS Receiver; select a channel other than 205 at the DSS Receiver.

2
Press the VCR button, then press the MENU button.

TO SELECT PUSH NO. SHOWN

1	PROGRAM
2	VCR SET UP
3	TUNER SET UP
4	INPUT SELECT
5	SET CLOCK
6	SET REMOTE LOCATOR

TO END PUSH EXIT

3
Press the Number 2 button to select VCR SET UP.

TO SELECT PUSH NO. SHOWN

1	SET REPEAT PLAY (OFF)
2	ON SCREEN MODE
3	LANGUAGE
4	SET VCR PLUS+ CH
5	SET CABLE BOX
6	SET DSS RECEIVER
7	AUDIO OUT
8	VIDEO STABILIZER (OFF)

TO END PUSH EXIT

4
Press the Number 6 button to select SET DSS RECEIVER.

DSS RECEIVER CONTROLLER

OFF

TO SELECT PRESS NUMBER

1	ON
2	OFF

TO CONTINUE PUSH MENU
TO END PUSH EXIT

5
Press the Number 1 button to set the DSS RECEIVER CONTROLLER to ON.

DSS RECEIVER CONTROLLER

ON

TO SELECT PRESS NUMBER

1	ON
2	OFF

TO CONTINUE PUSH MENU
TO END PUSH EXIT

Instructions continue on page 46.

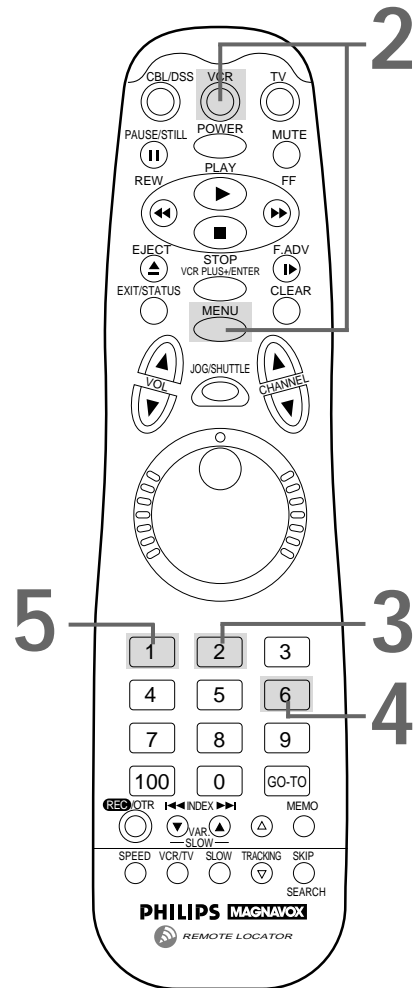

Helpful Hints

- The Controller can change channels at the DSS Receiver only during a timer recording.
- If the VCR's remote control does not operate your DSS Receiver, the Controller will not change channels at the DSS Receiver during a timer recording. In this case, you must select the channel to be recorded at the DSS Receiver before a timer recording begins. Leave the DSS Receiver on for the timer recording. Enter the DSS Receiver output channel (03 or 04) at step 5 on page 35. *Details are on page eight.*

46 Setting the Controller to Operate a DSS Receiver (cont'd)

6

Press the MENU button.

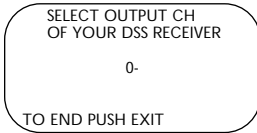

7

A zero will appear in the SELECT OUTPUT CH menu. Press one Number button (3 or 4) to complete the output channel of your DSS Receiver (channel 03 or 04).

- Press 0 if you connected the VIDEO/AUDIO OUT Jacks of the DSS Receiver to the VCR's VIDEO/AUDIO IN Jacks. A/V will appear on-screen as the output channel. A/V CONNECT A/V REAR ONLY will appear.
- If you make a mistake, press the CLEAR button, then enter the correct output channel.

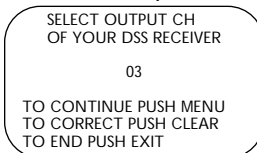

8

Press the MENU button.

9

A four will appear in the menu. Use the Number buttons to enter the second digit of the two-digit code for your DSS Receiver. (See the list on page 44.)

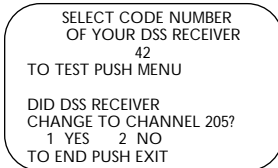

10

Press the MENU button. Wait for the DSS Receiver to change to channel 205. When it does, go to step 11.

- If the DSS Receiver does not change to channel 205, press the Number 2 button to select NO. Repeat steps 9 - 10. If the DSS Receiver doesn't change to channel 205, the Controller will not operate your DSS Receiver. Press the EXIT/STATUS button.

11

Press the Number 1 button to select YES.

"DSS RECEIVER CONTROL IS ON" will appear for five seconds. The screen will return to the program you were watching.

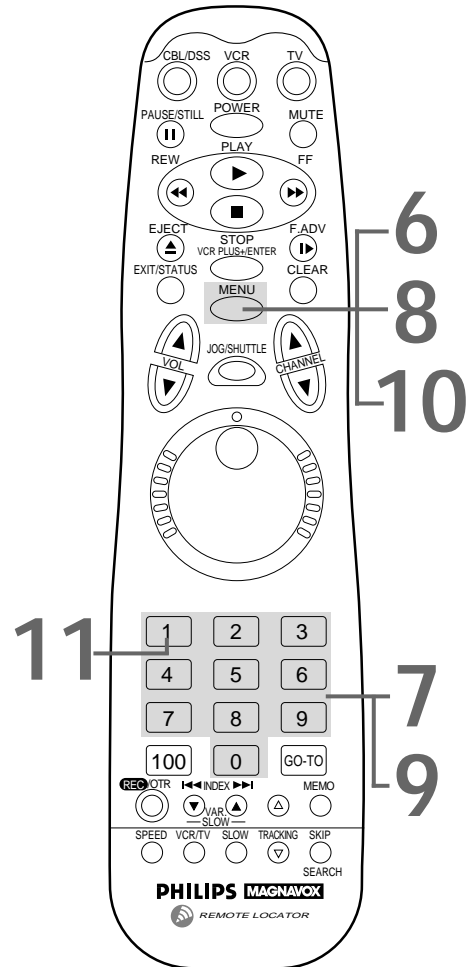

Helpful Hints

- If your DSS Receiver does not respond to the code in steps 9 - 10, the Controller will not change channels at the DSS Receiver during a timer recording. In this case, you must select the channel to be recorded at the DSS Receiver before a timer recording begins. Enter the DSS Receiver output channel (03 or 04) at step 5 on page 35. Leave the DSS Receiver on for the timer recording. Details are on page eight.
- If more than one code is listed for your brand of DSS Receiver, try all of the codes at steps 9 - 10 before you determine the Controller will not change the VCR channels.

Rerecording (Tape Duplication) 47

The instructions on this page show you how to copy tapes. Different VCRs may operate differently. To duplicate a tape, make the connections shown, then follow steps 1 - 6. (You may use the AUDIO and VIDEO IN jacks on the front of VCR 2 instead if you prefer.)

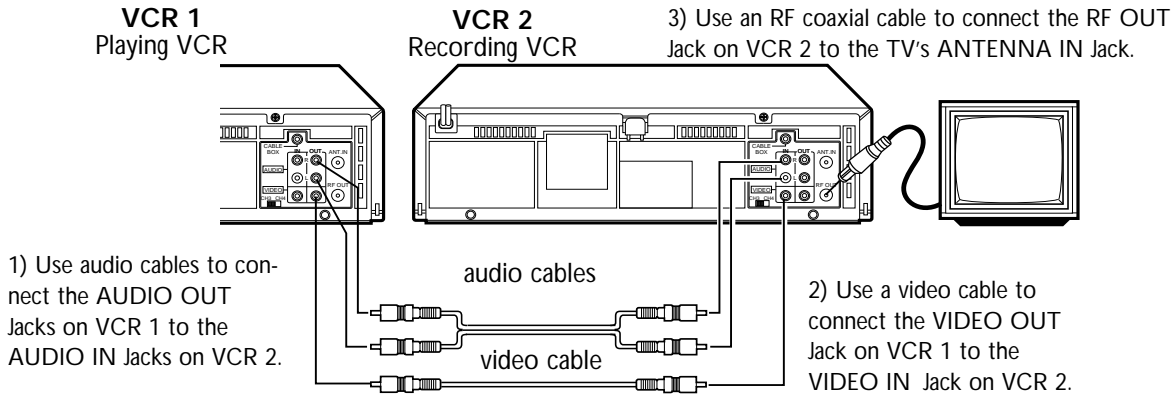

1

VCR 1 will play your tape. **Insert a prerecorded tape in VCR 1.** If the tape does not have a record tab, playback begins. If this happens, press the STOP/EJECT button on VCR 1 once.

2

VCR 2 will record your tape. **Insert a blank tape in VCR 2. Make sure the VCR power is on and the VCR is in VCR position.** (The VCR light will appear on the display panel. If it does not, press the VCR/TV button once.)

3

Turn on the TV; set it to channel 3 or 4, whichever channel the CH3/CH4 switch on VCR 2 is set to.

4

Point the remote control at VCR 2. Press the VCR button, then press the Number buttons 0, 0. L will appear on the display panel. (To record from the Front VIDEO/AUDIO IN Jacks, press the MENU button. Press the Number 4 button to select INPUT SELECT, then press the Number 3 button to select A/V IN FRONT. Press the EXIT/STATUS button.)

5

Point the remote control at VCR 2. Use the (Tape) SPEED button to select SP or SLP.

6

Press the PLAY button on VCR 1 and the REC(ord)/OTR button on VCR 2 at the same time. The REC(ord) light will appear on the VCR 2 display panel.

Helpful Hints

- *Unauthorized recording of copyrighted television programs, video tapes, or other materials may infringe on the rights of copyright owners and violate copyright laws.*
- *To record from the VIDEO/AUDIO IN Jacks on the back of the VCR at step 4, press the MENU button. Press the Number 4 button to select INPUT SELECT, then press the Number 2 button to select A/V IN REAR. Press the EXIT/STATUS button.*
- *Audio and video cables are not included.*
- *To stop copying tapes, press the STOP/EJECT button on VCR 2, then press the STOP/EJECT button on VCR 1.*

48 Index Search

When you make a recording, the VCR automatically places an index code at the beginning of the recording. Essentially, an index code is a type of "bookmark" for your tape. This feature is useful if you have several different programs recorded on a single tape.

Fast forward or rewind to the next or previous index code on the tape by following the steps below.

1

Press the VCR button.

2

Make sure the VCR is in VCR position. (The VCR light will appear on the display panel when the VCR is in VCR position.) **If the VCR light does not appear, press the VCR/TV button once.**

3

Insert a tape in the VCR.

4

Press the STOP button to stop tape playback, if necessary.

5

Press the INDEX/VAR.(iable) SLOW buttons to fast forward or rewind to the next or previous index code on the tape. Wait for the VCR to fast forward or rewind the tape. When the index code is reached, tape playback will begin.

3 Insert a tape.

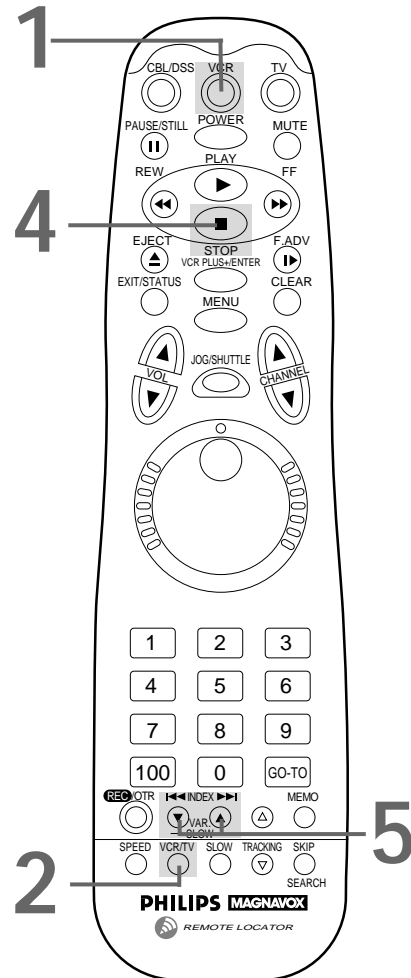

Helpful Hint

- The VCR does not place an index code at the point where a recording is paused, then resumed.

Multi-Channel Television Sound System 49

If a tape is recorded in stereo, the VCR will play the tape in stereo. If a TV program is broadcast in stereo, the VCR will receive the program in stereo. (You must program the VCR and make the appropriate stereo hookups. *Details are on pages 50 - 51.*)

Your VCR will do several additional things.

- **Second Audio** You can program your VCR so that you can hear a program that is being broadcast in second audio or a tape that was recorded in second audio. (A second audio broadcast is usually a program in a second language.) Follow the steps on page 50.
- **Hi-Fi Stereo Playback** You can program your VCR to play a tape in Hi-Fi (high fidelity) stereo. Follow the steps on page 51.
- **Hi-Fi Stereo Recording** You can program your VCR to receive and record a program broadcast in Hi-Fi stereo. Follow the steps on page 50.

Study the information below to familiarize yourself with your VCR's stereo, second audio, and Hi-Fi stereo options. Then go to page 50 to receive or record a program in stereo or second audio, or to page 51 to play a tape in Hi-Fi stereo.

Receiving a Stereo Broadcast

When a TV program is being broadcast in stereo, the ST (Stereo) light will appear on the display panel. This light means a stereo broadcast **is available**. You still have to program your VCR to receive the stereo broadcast. To receive and record a program broadcast in stereo, follow the steps on page 50.

Receiving a Second Audio Program

If a program is being broadcast in second audio, the SAP (Second Audio Program) light will appear on the display panel. This light means a second audio program **is available**. You still have to program your VCR to receive the second audio program. To receive and record a program broadcast in second audio, follow the steps on page 50.

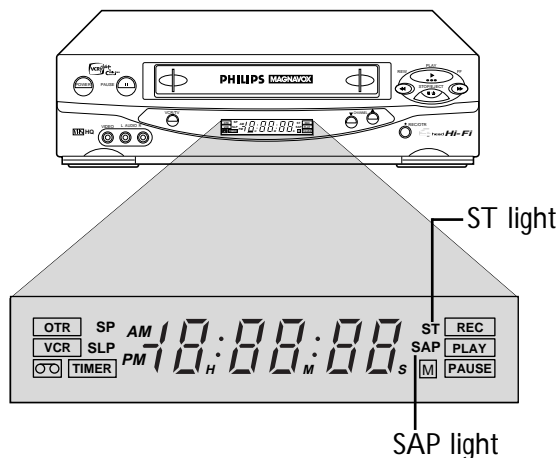

50 Multi-Channel Television Sound System (cont'd)

To receive and record programs broadcast in second audio, follow steps 1 - 10. To record a program broadcast in stereo, make one of the connections shown, then follow steps 1 - 10.

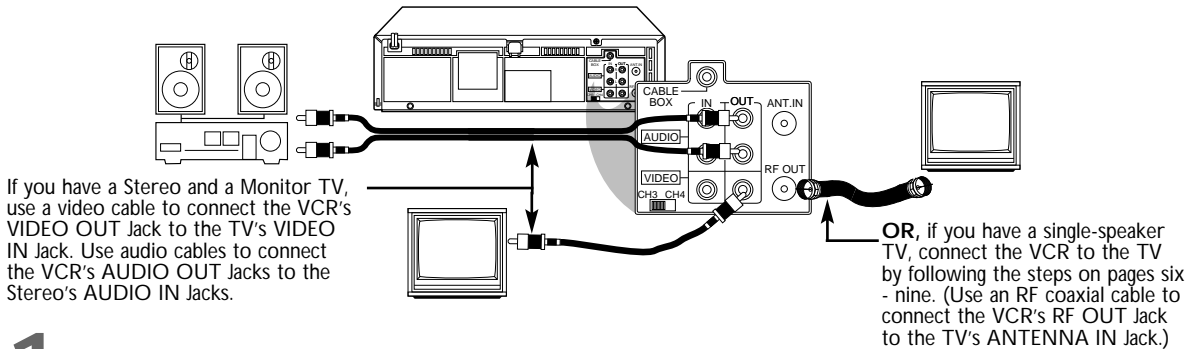

1

Press the VCR button, then press the MENU button.

2

Press the Number 4 button to select INPUT SELECT.

3

Press the Number 1 button so that (ON) appears beside TUNER.

4

Press the EXIT/STATUS button.

5

Press the MENU button.

6

Press the Number 3 button to select TUNER SET UP.

7

Press the Number 6 button to select TV STEREO or the Number 7 button to select SECOND AUDIO. (ON) will appear beside your selection. You can not record a program in both stereo and second audio at the same time.

8

Press the EXIT/STATUS button to exit.

9

Use the CHANNEL Up/Down buttons to select a channel to record.

10

Press the REC(ord)/OTR button to start recording.

Helpful Hints

- If you want to connect the VCR to a Stereo TV, follow these steps.
 - 1) Connect the antenna or cable signal to the VCR's ANT(enna) IN Jack.
 - 2) Use stereo audio cables to connect the VCR's AUDIO OUT Jacks to the TV's AUDIO IN Jacks.
 - 3) Use a video cable to connect the VCR's VIDEO OUT Jack to the TV's VIDEO IN Jack.
- Make sure the TV and the Stereo (if applicable) are in Line Input or Auxiliary mode. Please refer to your TV or Stereo owner's manual for details.

Hi-Fi Stereo Tape Playback 51

If a tape is recorded in Hi-Fi stereo, follow the steps below to play the tape in Hi-Fi stereo.

1

Press the VCR button, then press the MENU button.

2

Press the Number 2 button to select VCR SET UP.

3

Press the Number 7 button to select AUDIO OUT.

4

Press the Number 1 button to select HIFI. (ON) will appear beside HIFI.

5

Press the EXIT/STATUS button.

6

Press the MENU button.

7

Press the Number 3 button to select TUNER SET UP.

8

Press the Number 6 button to select TV STEREO. (ON) will appear beside TV STEREO.

9

Press the EXIT/STATUS button.

10

Press the PLAY button to start tape playback.

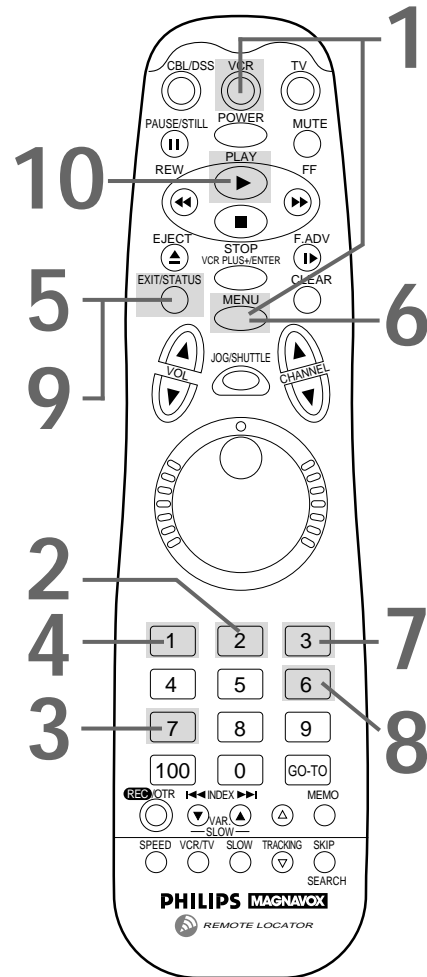

Helpful Hints

- During playback, Hi-Fi stereo may temporarily revert to normal audio when you adjust tracking. This is normal.
- If Hi-Fi stereo continually reverts to normal audio during playback, you may want to press the Number 2 button to select MONO at step 4.
- Only tapes recorded in Hi-Fi stereo will play in Hi-Fi stereo. Tapes recorded in normal audio will play in normal audio.

52 Tape Counter Memory

Using the Tape Counter

Follow the steps below to reset the tape counter to zero at a tape location you want to refer to later.

1

Play, fast forward, or rewind a tape to the location that you would like to refer to later. Press the **STOP** button to stop the tape.

2

Press the **EXIT/STATUS** button. The status display, which includes the tape counter, will appear on-screen.

3

While the tape counter is still on-screen, press the **CLEAR** button to reset the tape counter to zero.

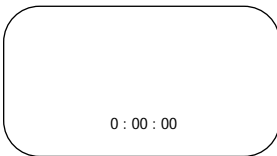

4

While the tape counter is still on-screen, press the **MEMO(ry)** button so that **M** appears beside the tape counter. The Memory light will appear on the display panel.

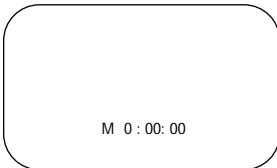

5

When tape playback is stopped, press the **REW(ind)** button or the **FF (Fast Forward)** button to go to the location on the tape at which the tape counter was reset to zero. Press the **PLAY** button to watch the tape.

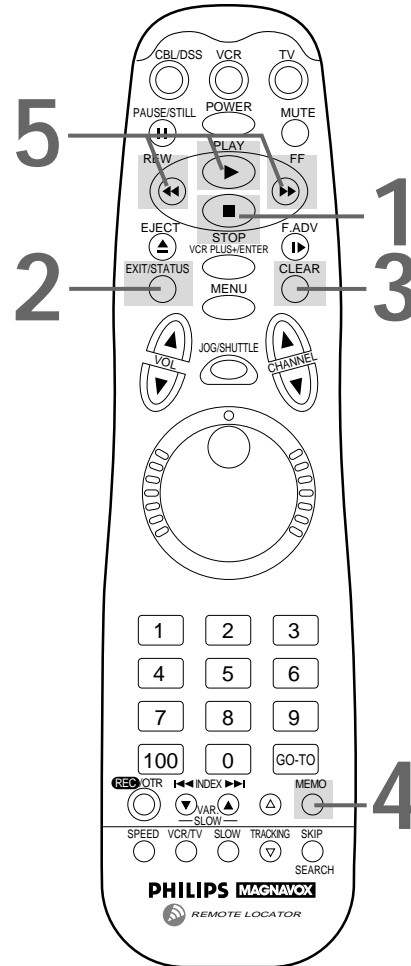

Helpful Hints

- You may only set the tape counter to zero at one location at a time. If you try to set a second tape counter location to zero, the previous tape counter to zero setting will be erased.
- To erase the tape counter memory, press the MEMO(ry) button. The Memory light will disappear from the display panel.
- The tape counter memory may not operate during Repeat Playback. Details are on page 54.

Go-To Feature 53

Follow the steps below to program the VCR to go to a place on a tape with a specified tape counter location number.

- Make sure the VCR is in VCR position. (The VCR light will appear on the display panel. If it does not, press the VCR/TV button once.)

1

Press the VCR button.

2

When tape playback is stopped, press the GO-TO button to bring up the GOTO display.

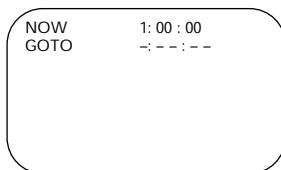

3

Within 10 seconds, use the Number buttons to enter the desired tape counter location number. For example, to go to tape counter location number 1:20:00, press Number buttons 1, 20, 00.

NOTE: If the desired tape counter location number has a minus (-) before it, enter the minus by pressing the CHANNEL Down button. Press the CHANNEL Up button to remove the minus.

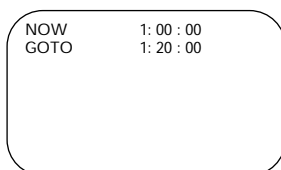

4

Within 10 seconds, press the PLAY, STOP, POWER, or REC(ord)/OTR button. The VCR will fast forward or rewind the tape to the selected tape counter location. Then, depending on which button you pressed, the VCR will either begin tape playback, stop the tape, turn itself off, or start recording the current channel.

Button pressed	VCR action
PLAY	Begin tape playback
STOP	Stop the tape
POWER	Turn off VCR
REC(ord)/OTR	Begin recording current channel

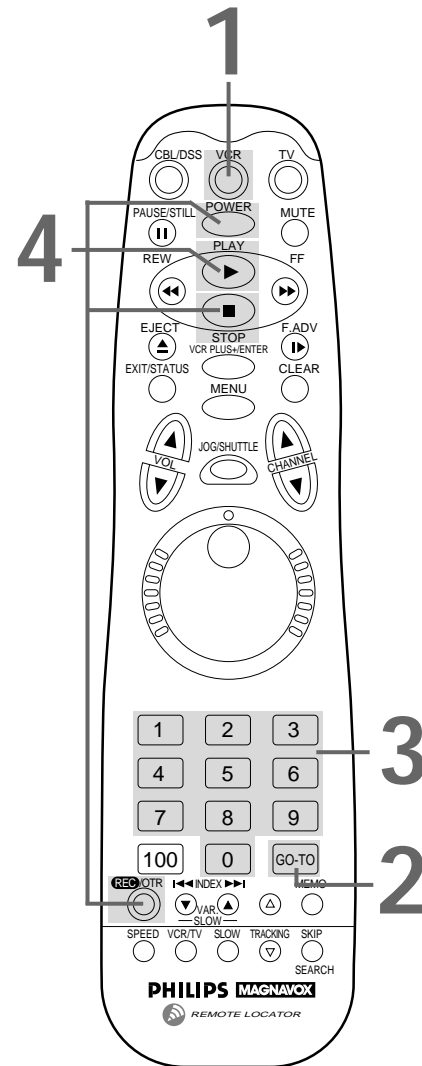

Helpful Hints

- To remove the GOTO display, press the GO-TO button again.
- The tape counter location number you enter at step 3 must be valid.
- To stop the tape during rewinding or fast forwarding (before the tape reaches the requested tape counter location number), press the STOP button.

54 Repeat Playback

Follow the steps below to program the VCR to play a tape over and over.

1

Press the **VCR** button, then press the **MENU** button.

TO SELECT PUSH NO. SHOWN

- 1 PROGRAM
- 2 VCR SET UP
- 3 TUNER SET UP
- 4 INPUT SELECT
- 5 SET CLOCK
- 6 SET REMOTE LOCATOR

TO END PUSH EXIT

2

Press the **Number 2** button to select VCR SET UP.

TO SELECT PUSH NO. SHOWN

- 1 SET REPEAT PLAY (OFF)
 - 2 ON SCREEN MODE
 - 3 LANGUAGE
 - 4 SET VCR PLUS+ CH
 - 5 SET CABLE BOX
 - 6 SET DSS RECEIVER
 - 7 AUDIO OUT
 - 8 VIDEO STABILIZER (OFF)
- TO END PUSH EXIT

3

Press the **Number 1** button so that **(ON)** appears to the right of **SET REPEAT PLAY**.

Each time you press the **Number 1** button, you turn SET REPEAT PLAY ON or OFF.

4

Press the **EXIT/STATUS** button. Now, when a tape has finished playing, the VCR will rewind it and start playback again. This will happen until the tape has played 20 times. The **PLAY** light on the display panel will flash during tape playback and while rewinding. TV programming will appear while the tape is rewinding.

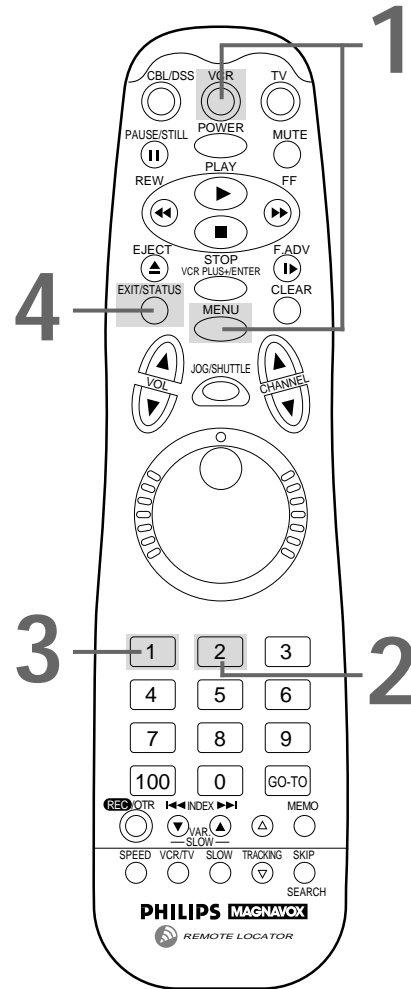

Helpful Hints

- The VCR will stay in Repeat Play mode until you cancel Repeat Play mode. To do this, follow steps 1 - 2 above. At step 3, press the **Number 1** button so that **(OFF)** appears to the right of **SET REPEAT PLAY**. Press the **EXIT/STATUS** button to exit.

Video Stabilizer 55

Video Stabilizer

You can correct vertical vibration when playing back tapes recorded in SLP speed. When Video Stabilizer is ON, vertical vibration will be corrected automatically. Video Stabilizer is OFF when you receive the VCR.

Follow the steps below to turn Video Stabilizer ON.

1

Press the VCR button, then press the MENU button.

TO SELECT PUSH NO. SHOWN

- 1 PROGRAM
- 2 VCR SET UP
- 3 TUNER SET UP
- 4 INPUT SELECT
- 5 SET CLOCK
- 6 SET REMOTE LOCATOR

TO END PUSH EXIT

2

Press the Number 2 button to select VCR SET UP.

TO SELECT PUSH NO. SHOWN

- 1 SET REPEAT PLAY (OFF)
- 2 ON SCREEN MODE
- 3 LANGUAGE
- 4 SET VCR PLUS+ CH
- 5 SET CABLE BOX
- 6 SET DSS RECEIVER
- 7 AUDIO OUT
- 8 VIDEO STABILIZER (OFF)

TO END PUSH EXIT

3

Press the Number 8 button so that (ON) appears to the right of VIDEO STABILIZER.

Each time you press the Number 8 button, you turn VIDEO STABILIZER ON or OFF.

TO SELECT PUSH NO. SHOWN

- 1 SET REPEAT PLAY (OFF)
- 2 ON SCREEN MODE
- 3 LANGUAGE
- 4 SET VCR PLUS+ CH
- 5 SET CABLE BOX
- 6 SET DSS RECEIVER
- 7 AUDIO OUT
- 8 VIDEO STABILIZER (ON)

TO END PUSH EXIT

4

Press the EXIT/STATUS button.

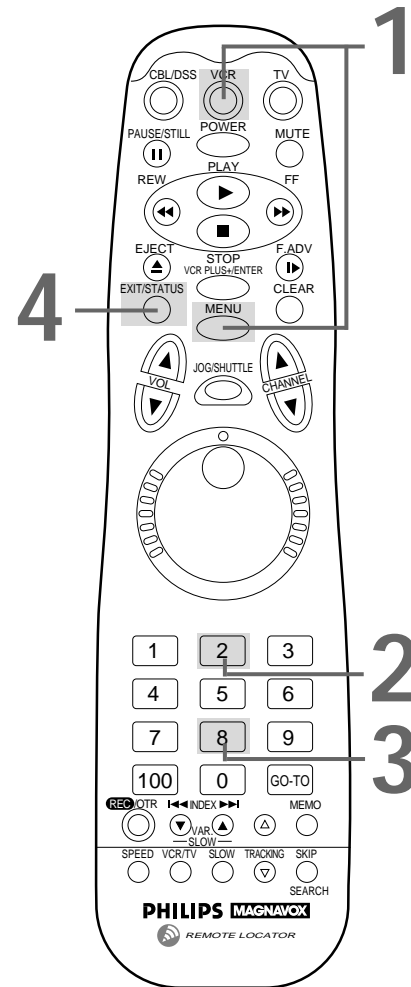

Helpful Hints

- Regardless of the setting, this function has no effect on tapes recorded in SP speed, during recording, and during special effects playback.
- When you finish viewing the tape, set VIDEO STABILIZER to OFF. Follow steps 1 - 2 above. At step 3, press the Number 8 button so that OFF appears to the right of VIDEO STABILIZER. Press the EXIT/STATUS button.

56 Playback Options

Forward and Reverse Searching

1

During tape playback, press and release the FF (Fast Forward) button or the REW(ind) button. A fast forward or reverse picture search will begin.

2

To return to playback, press the PLAY button.

Viewing a Still Picture

1

During tape playback, press the PAUSE/STILL button. A still picture (frozen image) will appear on-screen.

2

To advance the still picture frame-by-frame, press the F.(rame) ADV(ance) button.

3

To release the still picture and return to normal playback, press the PAUSE/STILL button or the PLAY button.

Viewing a Slow Motion Picture

1

During tape playback, press the SLOW button. The tape will play in slow motion.

2

Adjust the speed of slow motion playback by pressing the INDEX/VAR.(iable) SLOW buttons.

3

To return to normal playback, press the PLAY button.

Viewing Pictures in Slow to Fast Motion

1

First, press the JOG/SHUTTLE button while in the Play or Still mode. The JOG/SHUTTLE light will appear.

2

Next, turn the outer ring (the Shuttle ring) in either direction. The farther the ring is rotated, the faster the search speed. Releasing the ring stops the picture in the Still mode.

3

Or, turn the inner dial (the Jog Dial) in either direction. The tape will move frame-by-frame at the speed with which the dial is turned.

4

Press the PLAY button to release the Still mode.

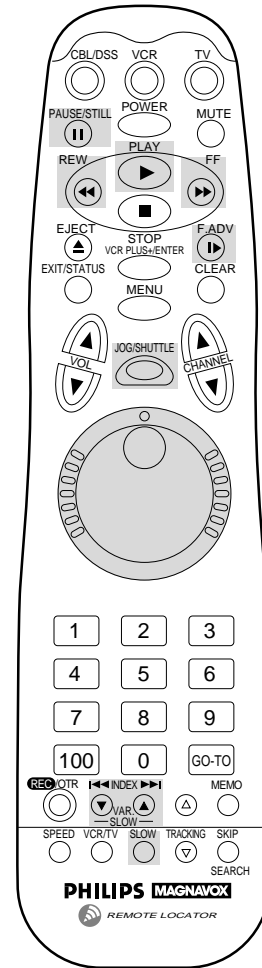

Helpful Hints

- During Search, Slow, and Still modes, there will be no sound.
- Slow and Still modes automatically switch to Stop mode after five minutes to protect the VCR and the tape from damage.
- During Forward or Reverse Searching, noise bars will appear on-screen.
- You may only view a tape in Slow Motion if the tape is recorded in SP or SLP speed.
- The Jog/Shuttle Light goes off after 60 seconds if no buttons are pressed.

Automatic Playback

When you put a tape in the VCR, the power will come on automatically. If the tape's record tab is missing, playback will begin.

Automatic Rewind

When a tape is played, fast forwarded, or recorded to its end, the VCR will rewind the tape to the beginning, then stop. If the Memory light appears on the display panel, the tape may stop at 0H00M00S on the tape counter.

Memory Rewind, Power Off

When the POWER button is pressed while the VCR is rewinding a tape, REWIND→POWER OFF will appear on-screen. When the tape has finished rewinding, the VCR will stop, then turn itself off. Or, if the Memory light appears on the display panel, the tape may stop at 0H00M00S on the tape counter. The VCR will turn itself off.

Tape Eject

A tape can be ejected with the VCR power on or off (but the VCR must be plugged in).

If a timer recording is programmed, the TIMER and Cassette-Inside lights will flash on the VCR's display panel when you eject a tape with the VCR power turned off.

Automatic Tracking Adjustment

The VCR continually adjusts tracking to give you the best possible picture quality. With some recordings, however, you may get a better picture by adjusting the tracking manually (see below).

Manual Tracking Adjustment

- Press the TRACKING Up/Down buttons to adjust tracking manually during normal and slow motion playback.
- Press the TRACKING buttons to eliminate vertical jitter in a Still picture.
- Press the CHANNEL Up/Down buttons on the VCR to remove jitter in a still picture.
- You can return to Automatic Tracking Adjustment by pressing the CHANNEL Up/Down buttons **on the VCR at the same time**.
- The CHANNEL Up/Down buttons **on the VCR** also adjust tracking during normal tape playback.
- The VCR returns to Automatic Tracking Adjustment whenever a tape is inserted.

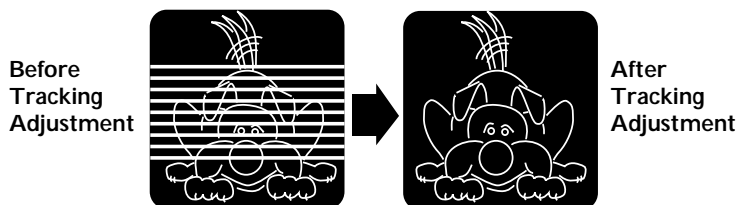

58 Glossary

AUDIO IN/OUT Jacks: jacks located on the front and back of the VCR which are used to record audio from another source (IN) or to send audio to another source (OUT).

Automatic Channel Programming: process in which the VCR scans all available channels and places the ones you receive in its memory. Then, when you press the CHANNEL Up/Down buttons, you only scan through channels you receive.

Bands: settings that allow you to tune channels.

- **Antenna** – VHF (very high frequency; channels 2 - 13) and UHF (ultra high frequency; channels 14 - 69).
- **Cable** – standard channels can be received without a Cable Box.

Cable Box/DSS Receiver Output Channel: channel 03 or 04.

DSS Receiver: Digital Satellite System Receiver.

Dubbing: copying a tape using a second VCR.

Frame: a single still picture.

HQ: high quality; a feature in the VCR circuitry which provides enhanced picture detail.

OTR: one touch recording; programming a timed recording that starts immediately and records for 30 minutes to nine hours, whichever you specify.

Remote Control: the small electronic unit that came with your VCR; allows you to operate your VCR from a distance. The remote control may also operate some features of your TV, Cable Box, or DSS Receiver.

RF coaxial cable: the cable supplied with your VCR. Use it to connect your VCR to your TV (or Cable Box or DSS Receiver, if applicable). The supplied cable is a snap-on type. However, you may also use a screw-on type if you prefer.

Special Effects: forward and reverse searching; viewing a still picture; or viewing a slow motion picture.

Tape Speeds: how fast the tape travels during a recording or playback.

- **LP (long play)** – average tape speed (playback time for a T120 tape is approximately four hours); available for playback only. Although the VCR will play tapes recorded in LP, LP will not appear on the display panel.
- **SLP (super long play)** – slowest tape speed (recording/playback time for a T120 tape is approximately six hours).
- **SP (standard play)** – fastest tape speed (recording/playback time for a T120 tape is approximately two hours); best picture quality.

VCR: video cassette recorder.

VIDEO IN/OUT Jacks: jacks located on the front and back of the VCR which are used to record video from another source (IN) or to send video to another source (OUT).

Video Heads

Four heads with Hi-Fi stereo

Video Signal

EIA standards; NTSC color

Antenna

VHF/UHF – 75 ohm external antenna terminal

VHF Output Signal

Channel 03 or 04 (switchable)

75 ohms unbalanced

Power Requirement

120V AC; 60 Hz

Power Consumption

21W

Operating Temperature

41°F (5°C) to 104°F (40°C)

Relative Humidity

10% to 80%

Weight

7.3 lbs. (3.3 kg.)

Dimensions

14-3/16" (W) x 3-3/4" (H) x 10-1/4" (D)

(360 mm x 94 mm x 274 mm)

Tuner Broadcast Channels

VHF: 2 - 13

UHF: 14 - 69

Cable TV Channels

VHF: 2 - 13

Midband: A – 1

Superband: J – W

Hyperband: A-5 – A-1

Special Channel: 5A

Ultraband: 37 – 94, 100 – 125

NOTE: Designs and specifications are subject to change without notice.

60 Helpful Hints

If you are having problems with your VCR, check the following list of problems and possible solutions before requesting service. You may be able to solve the problem yourself.

The VCR has no power.

- Make sure the power plug is completely connected to an AC (alternating current) outlet.
- Make sure the power is turned on.

A power failure occurred.

- Select a language and program channels, if prompted to do so. *Details are on pages 10 - 12 and 19.* Reset the clock. *Details are on pages 14 - 17.* You may also need to reprogram your timer recordings. *Details are on pages 34 - 41.*

The VCR cannot be controlled with the remote control.

- Aim the remote control directly at the VCR's remote sensor. *Details are on pages five and 23.*
- Remove all obstacles between the remote control and the VCR.
- Inspect and/or replace the batteries in the remote control. *Details are on page five.*
- Press the VCR button, then try the other buttons.

The VCR will not perform a timer recording.

- Make sure the recording start and stop times are set correctly. *Details are on pages 34 - 41.*
- Make sure there is a tape in the VCR.
- Make sure the tape has a record tab. *Details are on page five.*
- Make sure the VCR power is off.
- Make sure the clock is set. *Details are on pages 14 - 17.*
- The VCR may not perform or continue a timer recording if a power interruption of more than three minutes occurs, even if the power comes back on. If timer recordings are lost, - - : - - should appear on the display panel. But, even if you do not see this indication and the VCR operates normally, check programmed timer recordings.
- When you turn on the VCR after a power failure, this on-screen message may appear: POWER FAILURE OCCURRED. TIMER MEMORY CLEARED (IF PROGRAMMED) PLEASE SET PROGRAMS TO BE RECORDED AGAIN TO END PUSH EXIT. First, reset the clock. *Details are on pages 14 - 17.* Then, program channels. *Details are on page 12.* Finally, program the timer recordings again. *Details are on pages 34 - 41.*
- Finish programming a timer recording at least five minutes before the recording is scheduled to begin.
- If two timer recordings overlap, CLASH will appear on-screen. The earlier program has priority; the later program will not be recorded.
- If the VCR power is turned off for a timer recording and there isn't a tape in the VCR, the TIMER and Cassette-Inside lights will blink on the display panel.
- If the record tab on a tape is missing and you turn off the VCR to set a timer recording, the VCR will eject the tape. The TIMER and Cassette-Inside lights will blink on the display panel.
- 12 PM is noon; 12 AM is midnight.
- If you are using the Controller, enter the Cable Box/DSS Receiver channel you want to record at step 5 on page 35. If you are not using the Controller, enter the Cable Box/DSS Receiver output channel (03 or 04) at step 5 on page 35, then select the channel to be recorded at the Cable Box/DSS Receiver. Leave the Cable Box/DSS Receiver on for the timer recording.

Tape can't be inserted.

- Insert the tape window side up, with the record tab facing you.
- Make sure a tape isn't already in the VCR by pressing the STOP/EJECT button on the VCR or the EJECT button on the remote control.
- Gently push the center of the tape as you put it in the VCR. Never force a tape into the VCR.

Tape can't be removed.

- Make sure the power plug is completely connected to an AC (alternating current) outlet.

The motor (cylinder) rotates even when the VCR is in Stop mode.

- To enable the quick play mechanism, the cylinder will rotate for about five minutes. This is normal.

There is no playback picture, or the playback picture is noisy or contains streaks.

- Make sure the TV is on the same channel as the VCR's CH3/CH4 switch. *Details are on pages six - nine.*
- Make sure the VCR is in VCR position. *Details are on pages 21, 22, 24, and 33.*
- Make sure channel 3 or 4 is properly adjusted at the TV.
- Adjust the tracking. *Details are on page 57.*

The Number buttons won't work for channels above 69; channels above 13 cannot be received.

- Select CABLE TV from the TUNER SET UP menu, then let the VCR program the channels. *Details are on page 12.*

A TV program cannot be recorded.

- Check the connections between the VCR, your TV, the antenna/cable, and the Cable Box or DSS Receiver (if applicable). *Details are on pages six - nine.*
- Make sure channels are programmed correctly. *Details are on pages 12 - 13.*
- Make sure the tape has a record tab. *Details are on page five.*

TV programs cannot be watched normally.

- Put the VCR in TV position. *Details are on pages 21, 22, 24, and 33.*
- Check the connections between the VCR, TV, the antenna/cable, and the Cable Box or DSS Receiver (if applicable). *Details are on pages six - nine.*

Line Input mode is selected.

- If you accidentally enter Line Input mode (L will appear on the display panel), use the CHANNEL Up/Down buttons or the Number buttons to select another channel. Line Input mode is channel 00.

Daylight-Saving Time

- When automatic Daylight-Saving Time is set, the clock will change automatically as follows: on the first Sunday in April, from 2 a.m. to 3 a.m.; on the last Sunday in October, from 2 a.m. to 1 a.m.
- During the April time change, a timer recording programmed to start between 2 a.m. and 2:59 a.m. will not record. A timer recording programmed to end between 2 a.m. and 2:59 a.m. will end when the clock moves forward (2 a.m.).
- During the October time change, a timer recording cannot be started between the second 1 a.m. and 1:59 a.m.

Multi-Channel Television Sound System

- You can only receive and record in stereo or second audio programs that are broadcast in stereo or second audio. You can only play in stereo or second audio tapes that were recorded in stereo or second audio. *Details are on pages 49 - 51.*
- If you select second audio when second audio is not available, the VCR will record normal audio.
- When you program your VCR to record in stereo, broadcasts are recorded in Hi-Fi stereo.
- You will only get stereo sound if you use audio cables to connect the AUDIO OUT Jacks on the VCR to the AUDIO IN Jacks on your TV. The TV must be in Line Input mode. See your TV owner's manual for details.
- When you connect the AUDIO OUT Jacks on your VCR to the AUDIO IN Jacks on your TV, the stereo light on the TV might not glow. This is normal. If the VCR indicates you are receiving a stereo broadcast, you are. (The ST light will appear on the display panel of the VCR.)

Satellite Hookups

- Watching one TV channel while recording another may not be possible if you have a satellite hookup.
- You may have to set your TV to channel 3 or 4, then make your channel selections at the satellite box.

The VCR ejects the tape when the REC(ord)/OTR button is pressed or when the VCR power is turned off to set a timer recording.

- Make sure the tape has a record tab. *Details are on page five.*

**RENEWED
90 DAY
LIMITED WARRANTY**

Index 63

ac power cord	25	with a dss receiver	8 - 9	rf out jack	6 - 9, 25
accessories	64	with a stereo TV	50	safety precautions	3
ant(enna) in jack	6 - 9, 25	without a cable box	6 - 7	sap (second audio program) light	22
audio in/out jacks	24 - 25, 47, 58	index/var.(iable)		satellite hookups	61
automatic		slow buttons	20, 48, 56	searching	56
playback	57	index search feature	48	second audio broadcast	49
rewind	57	jog/shuttle button	21, 56	shuttle ring	21, 56
batteries	5	jog dial	21, 56	skip search button	20
cable box		language selection	19	slow button	20, 56
connections	8 - 9	limited warranty	62	slow motion	56
jack	25, 42	line input light	22	slp	36
output channel	8 - 9	line input mode	47, 61	sound program lights	22, 49, 61
code	27, 44	long play	36	sp	36
cable/tv channels	38 - 39	lp	36	specifications	59
cassette compartment	22	maintenance	5	speed (tape) button	21
cassette-inside light	22	memory		st (stereo) light	22
cb1/dss button	20	button	21, 52	standard play	36
ch3/ch4 switch	25	light	23	stereo broadcast	49
channel		rewind, power off	57	still picture	56
above 100	20	(tape counter)		stop button	21
adding	13	menu button	20	stop/eject button	24
deleting	13	mode lights	22	super long play	36
display	23	mts broadcast	49	table of contents	4
programming	12	mute button	20	tape	
reviewing	13	number buttons	20	counter display	28, 52
up/down buttons	21, 24, 57	on-screen		counter memory	28, 52
clear button	21, 52	off mode	28	duplication	47
clock		on mode	28	eject	57
display	23	status displays	28	speed	36, 58
setting	14-17	one-touch recording	32	speed lights	23, 36, 58
automatically	16 - 17	otr light	23, 32	time zone selection	15
manually	14	output channel	44, 46, 58	timer	
time zone selection	15	pause button	24, 31, 56	light	22, 36, 41
connections	6 - 9, 42, 50	pause light	22	recording	34 - 41
contents, table of	4	pause/still button	20, 31, 56	checking	37
controller	64	pbs channel selection		clearing	37
cable box	43 - 44	automatic	17	helpful hints	60
dss receiver	45 - 46	manual	16	programming	34 - 36
placement	42	play button	21, 24, 56	reviewing	37
controls		play light	22	with vcr plus+	38 - 41
remote	20 - 21	playback		tracking adjustment	57
vcr	22 - 25	features	49 - 55	tv	
counter memory	52	options	56	button	20
counter only mode	28	playing	30	controls	26
daylight-saving time	18, 61	pluscode programming number	40	hookups	6-9
display panel	22 - 23	power button	20, 24, 29	position	21, 24
dss receiver		program review	37	remote control code	26
connections	8 - 9, 42	rear panel	25	vcr	
controller	45 - 46	rec(ord)/otr button	20, 24, 31, 32	button	20
code	27, 44	record tab	5	light	22
duplication	47	recording		position	21, 24
eject button	21	basic	31	vcr plus+ channels	38 - 39
erase protection	5	one channel/watching		vcr plus+ cross ref. map	39
exit/status button	20, 28	another	33	vcr plus+ programming system	
f.(rame) adv(ance) button	21, 56	remote control		setting up	38 - 39
fast forward searching	56	buttons	20 - 21	timer recording	40 - 41
ff (fast forward) button	21, 24, 56	using	5	vcr plus+/enter button	20, 40 - 41
front panel	24	sensor	23	vcr/tv button	21, 24, 33
glossary	58	remote locator	29	video	
go-to button	20, 53	repeat playback	54	in/out jacks	24 - 25, 47, 58
go-to feature	53	rerecording	47	stabilizer	55
helpful hints	60 - 61	reverse searching	56	tapes	5, 36
hi-fi stereo playback	51	rew(ind) button	21, 24, 56	vol(ume) up/down buttons	20
hookups		rf coaxial cable	7-9, 47, 50, 58	warranty	62
with a cable box	8 - 9				

SUPPLIED ACCESSORIES

Check to be sure the items on this page are packed with your VCR. These accessories are provided to help you use or set up your VCR.

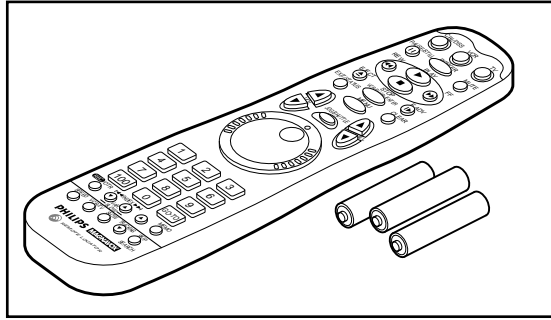

**Remote Control 4835 218 37196
Three "AA" Batteries 4835 138 17012**

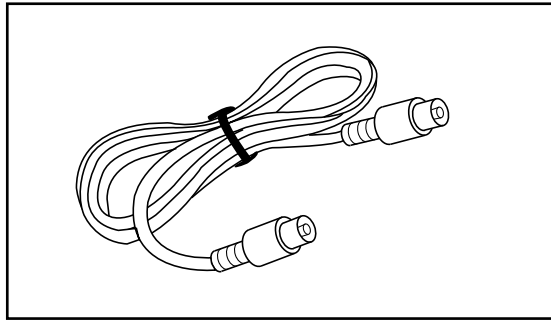

RF Coaxial Cable 4835 321 27302

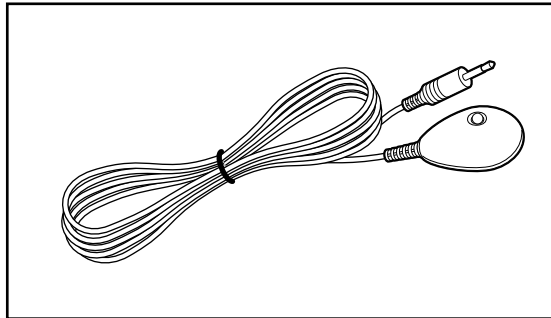

Controller 4835 321 27344

If any of these items are not included, or if you need to replace an item, contact Philips Service Company at the address below.

***Philips Service Company
P.O. Box 967
Greeneville, TN 37744-0967***

Or, call 1-800-851-8885.